



VALA

**PREMIUM
PPR-C
PIPE &
FITTING
SYSTEMS
TECHNICAL
CATALOG**

50 YEARS WARRANTY



VALA

TECHNICAL PROPERTIES OF PPR/C PIPES AND FITTINGS

Raw material: Polypropylene Random Copolymer, (TYPE 3)

Superior physical characteristics at 80 °C.

High chemical resistance,

Definite solutions to calcification and corrosion.

No bacteria and moss reproduction within the pipes.

Light, easy to install and low labour cost of installation.

Safe to use various pressurized liquids and gas.

No reduction in diameter at the welding points,

Longer service life, (50 years)

Isolation is not necessary in the buildings.

Operation Pressure: 20 Bars at 20 °C and 10 Bars at 90 °C.

Compared to the metal pipes it expands more and linearly.

Operation temperature is between 70 °C - 90 °C it does not absorb water. It can easily be used in hot and humid environment.

Can be used in drinking water systems and has quality certificates issued by The Ministry of Health and Hygiene Institute.

PHYSICAL & MECHANICAL PROPERTIES OF RAW MATERIAL (PPR-C)

Property		Unit	Test Method	Value
Density at	+23 °C	g/cm ³	ISO 1183	0,90-0,91
Melt Flow Index	MFR 190/5 MFR 230/2,16 MFR 230 /5	g/10 min g/10 min g/10 min	ISO 1133 ISO 1183 ISO 1183	0,4-0,6 0,2-0,5 0,8-0,13
Volume Flow Index	MVR 230/2,16 MVR 230/5	cm ³ / 10 min cm ³ / 10 min	ISO 1133 ISO 113	0,4 1,75
Yield Stress	50 mm/min	MPa	ISO 527	23-28
Elongation at Yield	50 mm/min	%	ISO 527	>10
Tensile Modulus	Secant	MPa	ISO 527	850
Ball Indentation Hardness	132 N / 30s	N/mm ²	ISO 2039/1	48
Short Hardness D	3 sec value		DIN 53505	65
Charpy Impact Strength at	+23 °C 0 °C -30 °C	kJ/m ² KJm ² kJ/m ²	ISO 179/1eU ISO 179/1eU ISO 179/1eU	no failure no failure 43
Charpy Notched Impact Strength at	+23 °C 0 °C -30 °C	kJ/m ² KJm ² kJ/m ²	ISO 179/1eA ISO 179/1eA ISO 179/1eA	22 4 2,5
Vicat Softening Temperature	VST/A50	°C	ISO 306	132
Heat Deflection Temperature	HDT A HDT B	°C °C	ISO 75/1+2 ISO 75/1+2	49 70
Melting Range	-	°C	DSC	145-150
Thermal Conductivity	-	W/mK	DIN 52612	0,24
Coefficient of Linear Thermal Expansion (Average, 20-90 oC)	-	1/K	DIN 53752	1,5.10 ⁻⁴
Surface Resistance	-	Ohm	DIN VDE 0303	>10 ¹⁴

Table 1

WELDING INSTRUCTIONS

The quality and the life span of any pipe installation depends equally on both the geometric accuracy and the weldings. Connecting pipes and fittings through melting takes just a few seconds. After a few minutes the welded pipe installation is ready to be installed.

You cut the pipe, heat the fitting with the welding machine and then connect the two parts. That's all Fast, without substantial efforts and with wonderful result.

All welded connections are completely safe because when the polypropilene cools down there's no change in its structure, shape or durability.



INSTRUCTIONS FOR WELDING PIPES AND FITTINGS

1. Choose the **appropriate detail and put it on the welding machine.**
2. Turn on the welding machine. Wait until the two control indicators are heating. When the device is ready for use the indicator turns off. This means that the necessary temperature has been reached /260°C +/- 10°C /
3. Attach properly the end of the pipe and the fitting to the welding device.
4. If the pipe or the **fitting is dirty, clean it with water and alcohol solution.**
5. Then heat equally for the duration of few seconds both the pipe and the **fitting. Then connect them and leave them** for a few minutes to cool down so that the welding be successful.
6. The necessary heating time, welding time and cool-down time for each corresponding pipe diameter is shown in the following table.

External Pipe Diameter mm	Insert Depths mm	Heating Perion Secs	Processing Period Secs	Cooling Period mins
16	13	5	4	2
20	14	5		
25	15	7		
32	16,5	8	6	4
40	18	12		
50	20	18		
63	24	24	8	6
75	26	30	10	8



Container Information

Standard Container

20ft x 8 ft 6 in / 6.1m x 2.4m x 2.6m					
Average Internal Dimensions			Door Dimensions		Average
L1	B1	H1	B2	H2	(m ³)
5,890mm	2,345mm	2,400mm	2,335 mm	2,290mm	33.3



Empty container weight is between 1.800 kg and 2,500 kg
Maximum carrying capacity is between gross 22,860 and 30,480 kg

40 Foot Standard Container

40ft x 8ft x 8ft 6in / 12.2 m x 2.4 m x 2.6m					
Average Internal Dimensions			Door Dimensions		Average
L1	B1	H1	B2	H2	(m ³)
12,015 mm	2,345 mm	2,362 mm	2,335 mm	2,260 mm	66.9



Empty container weight is between 3.700 kg and 4.380 kg
Maximum carrying capacity is gross 30.480 kg

40 Foot High cube Container

40ft x 8ft x 9ft 6in / 12.2 m x 2.4 m x 2.9m					
Average Internal Dimensions			Door Dimensions		Average
L1	B1	H1	B2	H2	(m ³)
12,015 mm	2,345 mm	2,690 mm	2,335 mm	2,580 mm	76.0



Empty container weight is 3.980 kg
Maximum carrying capacity is gross 30.480 kg

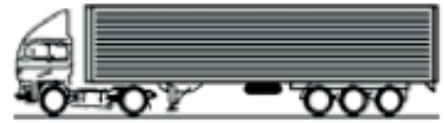

Truck Type	L	W	H	m ³
Tilt Truck	13,60	2,42	2,40	79
	13,60	2,42	2,60	86

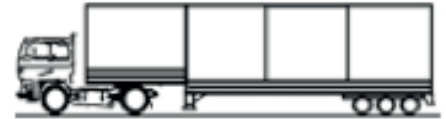

Truck Type	L	W	H	m ³
Jumbo Truck	3,10	2,42	2,55	79
	9,10	2,42	2,75	79
	3,50	2,42	2,45	83
	8,70	2,42	2,95	83



Truck Type	L	W	H	m ³
Normal Truck with Trailer (Optima)	6,20	2,42	2,50	87
	8,30	2,42	2,50	87

Vehicle Type	Gross Capacity	Gross Loading Capacity Box Type 1 (0,021 m ³)	Gross Loading Capacity Box Type 2 (0,032 m ³)
20 DC	33,3 m ³	1585 units	1040 units
40 DC	66,9 m ³	3185 units	2090 units
40 HC	76 m ³	3619 units	2375 units
Tilt Truck	79 m ³	3761 units	2468 units
Jumbo Truck	80 m ³	3809 units	2500 units
Normal Truck with Trailer	87 m ³	4142 units	2718 units



PPR-C (PN16) BORU / PIPE / ТРУБА



CODE КОД	SIZE (Ø) РАЗМЕР	1 BOX QUANTITY ЕД. В 1 КОРОБКЕ	WEIGHT (kg) ВЕС ЗА ЕД.	BOX SIZE (m ³) РАЗМЕР КОРОБ.
4419720	Ø20x2,8mm	140 m	0,135	0,067
4419725	Ø25x3,5 mm	100 m	0,218	0,067
4419732	Ø32x4,4 mm	60 m	0,350	0,069
4419740	Ø40x5,5 mm	40 m	0,545	0,072
4419750	Ø50x6,9 mm	20 m	0,840	0,065
4419763	Ø63x8,6 mm	16 m	1,330	0,070
4419775	Ø75x10,3 mm	12 m	1,890	0,070
4419790	Ø90x12,3 mm	8 m	2,640	0,068
4419711	Ø110x15,1 mm	4 m	3.900	0,052

PPR-C (PN20) BORU / PIPE / ТРУБА



CODE КОД	SIZE (Ø) РАЗМЕР	1 BOX QUANTITY ЕД. В 1 КОРОБКЕ	WEIGHT (kg) ВЕС ЗА ЕД.	BOX SIZE (m ³) РАЗМЕР КОРОБ.
4420020	Ø20x3,4 mm	140 m	0,160	0,067
4420025	Ø25x4,2 mm	100 m	0,245	0,067
4420032	Ø32x5,4 mm	60 m	0,395	0,069
4420040	Ø40x6,7 mm	40 m	0,625	0,072
4420050	Ø50x8,4 mm	20 m	0,975	0,065
4420063	Ø63x10,5 mm	16 m	1,550	0,070
4420075	Ø75x12,5 mm	12 m	2,190	0,070
4420090	Ø90x15,0 mm	8 m	3,100	0,068
4420011	Ø110x18,4 mm	4 m	4,560	0,052

PPR-C (PN20) FİBER BORU / COMPOSITE PIPE (GF) ТРУБА АРМИРОВАННАЯ СТЕКЛОВОЛОКНОМ



CODE КОД	SIZE (Ø) РАЗМЕР	1 BOX QUANTITY ЕД. В 1 КОРОБКЕ	WEIGHT (kg) ВЕС ЗА ЕД.	BOX SIZE (m ³) РАЗМЕР КОРОБ.
4419820	Ø20x2,8 mm	140 m	0,150	0,067
4419825	Ø25x3,5 mm	100 m	0,228	0,067
4419832	Ø32x4,4 mm	60 m	0,365	0,069
4419840	Ø40x5,5 mm	40 m	0,560	0,072
4419850	Ø50x6,9 mm	20 m	0,890	0,065
4419863	Ø63x8,6 mm	16 m	1,365	0,070
4419875	Ø75x10,3 mm	12 m	1,970	0,070
4419890	Ø90x12,3 mm	8 m	2,815	0,068
4419811	Ø110x15,1 mm	4 m	3,975	0,052

PPR-C (PN25) FİBER BORU / COMPOSITE PIPE (GF) ТРУБА АРМИРОВАННАЯ СТЕКЛОВОЛОКНОМ



CODE КОД	SIZE (Ø) РАЗМЕР	1 BOX QUANTITY ЕД. В 1 КОРОБКЕ	WEIGHT (kg) ВЕС ЗА ЕД.	BOX SIZE (m ³) РАЗМЕР КОРОБ.
4419620	Ø20x3,4 mm	140 m	0,160	0,067
4419625	Ø25x4,2 mm	100 m	0,250	0,067
4419632	Ø32x5,4 mm	60 m	0,415	0,069
4419640	Ø40x6,7 mm	40 m	0,648	0,072
4419650	Ø50x8,4 mm	20 m	1,010	0,065
4419663	Ø63x10,5 mm	16 m	1,580	0,070
4419675	Ø75x12,5 mm	12 m	2,220	0,070
4419690	Ø90x15,0 mm	8 m	3,100	0,068
4419611	Ø110x18,4 mm	4 m	5,450	0,052



PPR-C (PN25) AL. FOLYOLU BORU / INSIDE ALM. FOLIED PIPE / ТРУБА С АЛ. Ф.

CODE КОД	SIZE (Ø) РАЗМЕР	1 BOX QUANTITY ЕД. В 1 КОРОБКЕ	WEIGHT (kg) ВЕС ЗА ЕД.	BOX SIZE (m ³) РАЗМЕР КОРОБ.
4419920	Ø20x3,4 mm	140m	0,177	0,067
4419925	Ø25x4,2 mm	100m	0,268	0,067
4419932	Ø32x5,4 mm	60m	0,433	0,069
4419940	Ø40x6,7 mm	40m	0,665	0,072
4419950	Ø50x8,4 mm	20m	1,027	0,065
4419963	Ø63x12 mm	16m	1,620	0,070



PPR-C (PN20+) BORU BLUE FUSION / PIPE BLUE FUSION / ТРУБА БЛУЕ ФУЖЫН

CODE КОД	SIZE (Ø) РАЗМЕР	1 BOX QUANTITY ЕД. В 1 КОРОБКЕ	WEIGHT (kg) ВЕС ЗА ЕД.	BOX SIZE (m ³) РАЗМЕР КОРОБ.
4419520	Ø20x3,4 mm	140m	0,160	0,067
4419525	Ø25x4,2 mm	100m	0,245	0,067
4419532	Ø32x5,4 mm	60m	0,395	0,079
4419540	Ø40x6,7 mm	40m	0,625	0,072
4419550	Ø50x8,4 mm	20m	0,975	0,065
4419563	Ø63x10,5 mm	16m	1,550	0,070
4419575	Ø75x12,5 mm	12m	2,190	0,070
4419590	Ø90x15 mm	8m	3,100	0,068
4419511	Ø110x18,4 mm	4m	4,750	0,052



PPR-C MANŞON / SOCKET / МУФТА

CODE КОД	SIZE (Ø) РАЗМЕР	1 BOX QUANTITY ЕД. В 1 КОРОБКЕ	WEIGHT (kg) ВЕС ЗА ЕД.	BOX SIZE (m ³) РАЗМЕР КОРОБ.
4420120	Ø20 mm	600	0,010	0,027
4420125	Ø25 mm	400	0,014	0,027
4420132	Ø32 mm	200	0,030	0,027
4420140	Ø40 mm	100	0,043	0,027
4420150	Ø50 mm	70	0,076	0,027
4420163	Ø63 mm	48	0,136	0,027
4420175	Ø75 mm	28	0,191	0,027
4420190	Ø90 mm	16	0,266	0,027
4420111	Ø110 mm	8	0,635	0,027

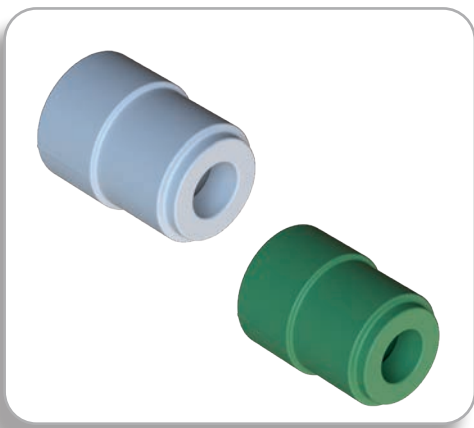

PPR-C REDÜKSİYON / REDUCTION / ПЕРЕХОДНАЯ МУФТА

CODE КОД	SIZE (Ø) РАЗМЕР	1 BOX QUANTITY ЕД. В 1 КОРОБКЕ	WEIGHT (kg) ВЕС ЗА ЕД.	BOX SIZE (m ³) РАЗМЕР КОРОБ.
4420225	Ø25 x 20mm	600	0,010	0,027
4420232	Ø32 x 20mm	400	0,016	0,027
4420233	Ø32 x 25mm	400	0,018	0,027
4420240	Ø40 x 20mm	275	0,025	0,027
4420241	Ø40 x 25mm	225	0,025	0,027
4420242	Ø40 x 32mm	200	0,030	0,027
4420250	Ø50 x 25mm	140	0,036	0,027
4420251	Ø50 x 32mm	140	0,040	0,027
4420252	Ø50 x 40mm	110	0,048	0,027
4420262	Ø63 x 32mm	80	0,055	0,027
4420263	Ø63 x 40mm	70	0,094	0,027
4420264	Ø63 x 50mm	60	0,100	0,027
4420275	Ø75 x 32mm	50	0,120	0,027
4420276	Ø75 x 40mm	35	0,115	0,027
4420277	Ø75 x 50mm	35	0,130	0,027
4420278	Ø75 x 63mm	32	0,163	0,027
4420290	Ø90 x 63mm	32	0,281	0,027
4420291	Ø90 x 75mm	32	0,248	0,027

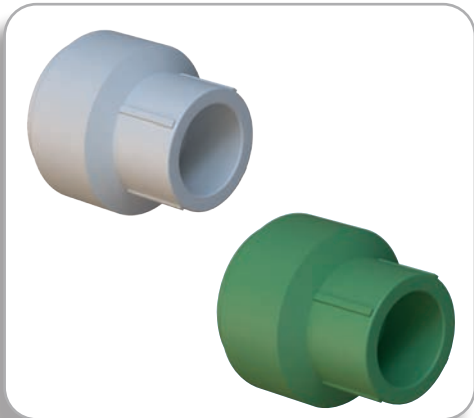

PPR-C REDÜKSİYON / REDUCTION / ПЕРЕХОДНАЯ МУФТА

CODE КОД	SIZE (Ø) РАЗМЕР	1 BOX QUANTITY ЕД. В 1 КОРОБКЕ	WEIGHT (kg) ВЕС ЗА ЕД.	BOX SIZE (m ³) РАЗМЕР КОРОБ.
4428925	Ø25 x 20mm		0,014	0,027
4428932	Ø32 x 20mm		0,019	0,027
4428933	Ø32 x 25mm		0,020	0,027

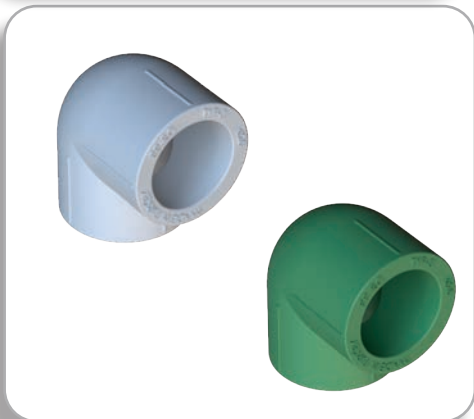

PPR-C (90°) DİRSEK / ELBOW / УГОЛЬНИК

CODE КОД	SIZE (Ø) РАЗМЕР	1 BOX QUANTITY ЕД. В 1 КОРОБКЕ	WEIGHT (kg) ВЕС ЗА ЕД.	BOX SIZE (m ³) РАЗМЕР КОРОБ.
4420320	Ø20mm	400	0,014	0,027
44E0325	Ø25mm	300	0,020	0,027
4420325	Ø25mm (LUX)	250	0,026	0,027
4420332	Ø32mm	125	0,038	0,027
4420340	Ø40mm	90	0,062	0,027
4420350	Ø50mm	40	0,123	0,027
4420363	Ø63mm	20	0,244	0,027
4420375	Ø75mm	18	0,380	0,027
4420390	Ø90mm	8	0,578	0,027
4420311	Ø110mm	3	0,960	0,027

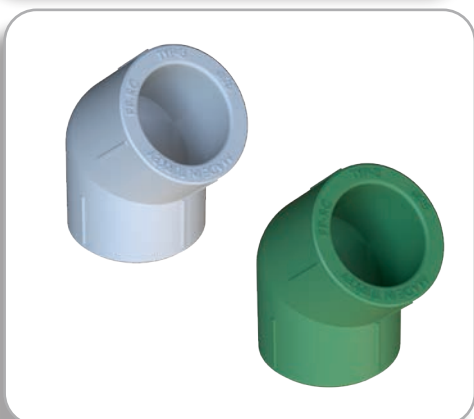

PPR-C (45°) DİRSEK / ELBOW / УГОЛЬНИК

CODE КОД	SIZE (Ø) РАЗМЕР	1 BOX QUANTITY ЕД. В 1 КОРОБКЕ	WEIGHT (kg) ВЕС ЗА ЕД.	BOX SIZE (m ³) РАЗМЕР КОРОБ.
4420420	Ø20mm	450	0,011	0,027
4420425	Ø25mm	300	0,017	0,027
4420432	Ø32mm	175	0,029	0,027
4420440	Ø40mm	100	0,067	0,027
4420450	Ø50mm	60	0,082	0,027
4420463	Ø63mm	20	0,236	0,027
4420475	Ø75mm	12	0,392	0,027
4420490	Ø90mm	10	0,557	0,027
4420411	Ø110mm	4	0,915	0,027

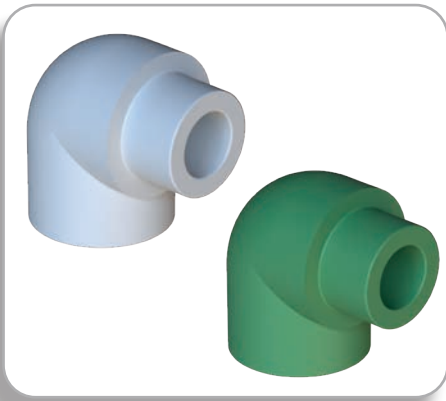

**PPR-C (90°) KUYUKLU DİRSEK
TAILED ELBOW
УГОЛЬНИК ПЕРЕХОДНОЙ ВН. НАР.**

CODE КОД	SIZE (Ø) РАЗМЕР	1 BOX QUANTITY ЕД. В 1 КОРОБКЕ	WEIGHT (kg) ВЕС ЗА ЕД.	BOX SIZE (m ³) РАЗМЕР КОРОБ.
4423920	Ø20mm	500	0,017	0,027
4423925	Ø25mm	300	0,021	0,027

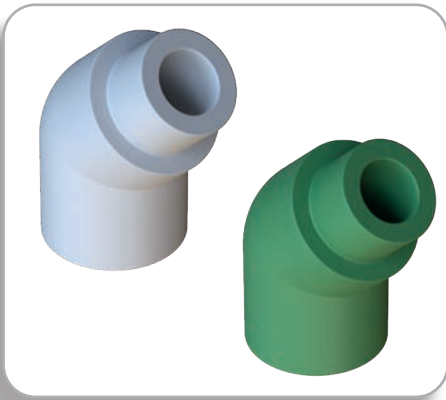

**PPR-C (45°) KUYUKLU DİRSEK / TAILED ELBOW /
УГОЛЬНИК ПЕРЕХОДНОЙ ВН. НАР.**

CODE КОД	SIZE (Ø) РАЗМЕР	1 BOX QUANTITY ЕД. В 1 КОРОБКЕ	WEIGHT (kg) ВЕС ЗА ЕД.	BOX SIZE (m ³) РАЗМЕР КОРОБ.
4424020	Ø20mm	500	0,017	0,027
4424025	Ø25mm	400	0,026	0,027



**PPR-C REDÜKSİYON DİRSEK / REDUCTION ELBOW /
ПЕРЕХОДНАЯ МУФТА УГОЛЬНИК**

CODE КОД	SIZE (Ø) РАЗМЕР	1 BOX QUANTITY ЕД. В 1 КОРОБКЕ	WEIGHT (kg) ВЕС ЗА ЕД.	BOX SIZE (m ³) РАЗМЕР КОРОБ.
4428325	Ø20x25mm	225	0,000	0,027
4428332	Ø32x25mm	160	0,032	0,027

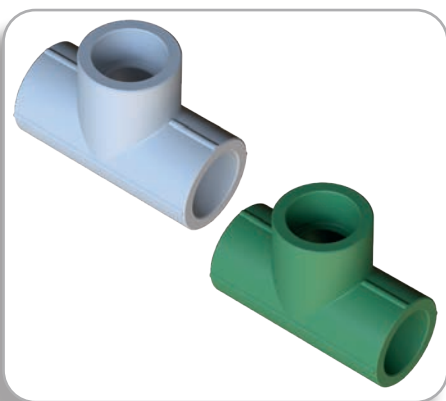

PPR-C TE PARÇASI / TEE PIECE / ТРОЙНИК

CODE КОД	SIZE (Ø) РАЗМЕР	1 BOX QUANTITY ЕД. В 1 КОРОБКЕ	WEIGHT (kg) ВЕС ЗА ЕД.	BOX SIZE (m ³) РАЗМЕР КОРОБ.
4420720	Ø20mm	300	0,020	0,027
4420725	Ø25mm	175	0,028	0,027
4420732	Ø32mm	100	0,051	0,027
4420740	Ø40mm	50	0,081	0,027
4420750	Ø50mm	25	0,154	0,027
4420763	Ø63mm	16	0,302	0,027
4420775	Ø75mm	12	0,465	0,027
4420790	Ø90mm	5	0,975	0,027
4420711	Ø110mm	2	1,420	0,027

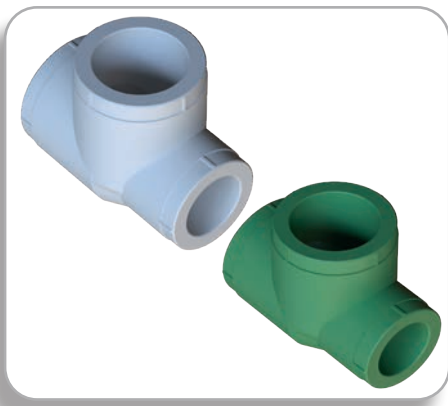

PPR-C İNEĞAL TE / REDUCTION TEE PIECE / ТРОЙНИК ПЕРЕХОДНОЙ

CODE КОД	SIZE (Ø) РАЗМЕР	1 BOX QUANTITY ЕД. В 1 КОРОБКЕ	WEIGHT (kg) ВЕС ЗА ЕД.	BOX SIZE (m ³) РАЗМЕР КОРОБ.
4420820	Ø25 x 20 x 20 mm	200	0,034	0,027
4420821	Ø25 x 25 x 20 mm	200	0,034	0,027
4420825	Ø25 x 20 x 25 mm	175	0,031	0,027
4420826	Ø32 x 20 x 20 mm	100	0,071	0,027
4420827	Ø32 x 25 x 20 mm	100	0,067	0,027
4420828	Ø32 x 32 x 20 mm	100	0,064	0,027
4420832	Ø32 x 20 x 32 mm	100	0,060	0,027
4420833	Ø32 x 25 x 32 mm	100	0,063	0,027
4420840	Ø40 x 20 x 40 mm	70	0,091	0,027
4420841	Ø40 x 25 x 40 mm	60	0,091	0,027
4420842	Ø40 x 32 x 40 mm	60	0,105	0,027
4420850	Ø50 x 20 x 50 mm	42	0,250	0,027
4420851	Ø50 x 25 x 50 mm	30	0,242	0,027
4420852	Ø50 x 32 x 50 mm	30	0,225	0,027
4420853	Ø50 x 40 x 50 mm	25	0,208	0,027
4420860	Ø63 x 20 x 63 mm	24	0,392	0,027
4420861	Ø63 x 25 x 63 mm	24	0,248	0,027
4420862	Ø63 x 32 x 63 mm	20	0,246	0,027
4420863	Ø63 x 40 x 63 mm	20	0,360	0,027
4420864	Ø63 x 50 x 63 mm	20	0,345	0,027

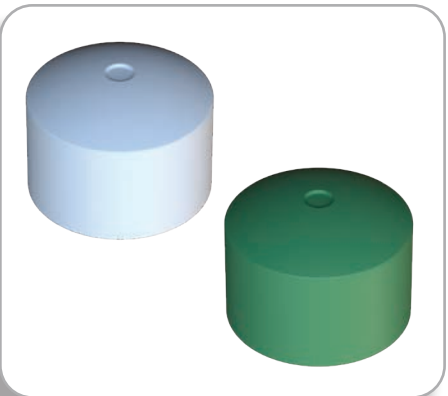

PPR-C KARAMA BAŞLIĞI / END CAP / ЗАГЛУШКА

CODE КОД	SIZE (Ø) РАЗМЕР	1 BOX QUANTITY ЕД. В 1 КОРОБКЕ	WEIGHT (kg) ВЕС ЗА ЕД.	BOX SIZE (m ³) РАЗМЕР КОРОБ.
4420920	Ø20mm	1000	0,007	0,027
4420925	Ø25mm	700	0,010	0,027
4420932	Ø32mm	400	0,016	0,027
4420940	Ø40mm	200	0,028	0,027
4420950	Ø50mm	140	0,046	0,027
4420963	Ø63mm	60	0,105	0,027

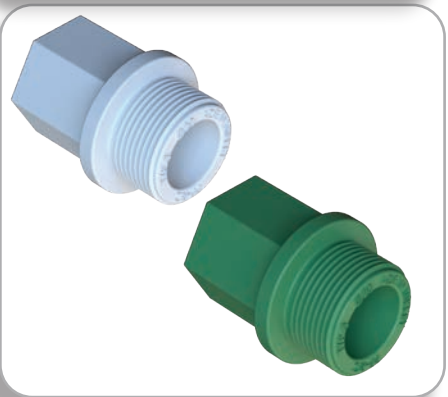

PPR-C DIŞLİ UZUN KÖR TAPA / LONG BLIND CAP / ЗАГЛУШКА РЕЗБОВАЯ

CODE КОД	SIZE (Ø) РАЗМЕР	1 BOX QUANTITY ЕД. В 1 КОРОБКЕ	WEIGHT (kg) ВЕС ЗА ЕД.	BOX SIZE (m ³) РАЗМЕР КОРОБ.
4422220	Ø20mm	3000	0,008	0,096
4422225	Ø25mm	3000	0,007	0,096
4422232	Ø32mm	2000	0,011	0,096



PPR-C TERAZİ TAPASI / TEST TAP / АГЛУШКА ДЛИННАЯ С РЕЗЬБОЙ.

CODE КОД	SIZE (Ø) РАЗМЕР	1 BOX QUANTITY ЕД. В 1 КОРОБКЕ	WEIGHT (kg) ВЕС ЗА ЕД.	BOX SIZE (m ³) РАЗМЕР КОРОБ.
4423820	Ø20 mm	1800	0,008	0,096
4423825	Ø20 mm (LONG)	1000	0,019	0,096



PPR-C KISA KAVİS C / SHORT CROSSOVER / КОРОТКИЙ ОБВОД

CODE КОД	SIZE (Ø) РАЗМЕР	1 BOX QUANTITY ЕД. В 1 КОРОБКЕ	WEIGHT (kg) ВЕС ЗА ЕД.	BOX SIZE (m ³) РАЗМЕР КОРОБ.
4423720	Ø20 mm	200	0,029	0,027
4423725	Ø25mm	125	0,039	0,027
4423732	Ø32 mm	80	0,055	0,027



PPR-C UZUN KAVİS MANŞONLU / LONG CROSSOVER / ОБВОД

CODE КОД	SIZE (Ø) РАЗМЕР	1 BOX QUANTITY ЕД. В 1 КОРОБКЕ	WEIGHT (kg) ВЕС ЗА ЕД.	BOX SIZE (m ³) РАЗМЕР КОРОБ.
4420520	Ø20 mm	125	0,034	0,027
4420525	Ø25 mm	75	0,060	0,027
4420532	Ø32 mm	35	0,110	0,027

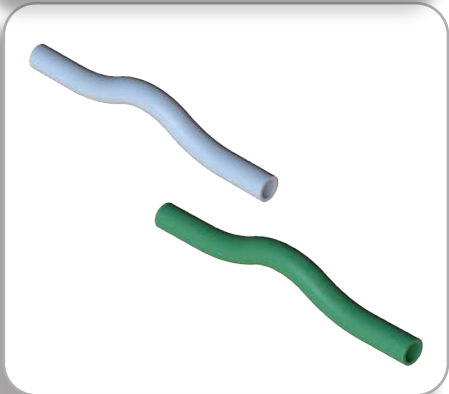

PPR-C UZUN KAVİS MANŞONSUZ CROSSOVER LONG WITHOUT SOCKET ДЛИННЫЙ ОБВОД

CODE КОД	SIZE (Ø) РАЗМЕР	1 BOX QUANTITY ЕД. В 1 КОРОБКЕ	WEIGHT (kg) ВЕС ЗА ЕД.	BOX SIZE (m ³) РАЗМЕР КОРОБ.
4427020	Ø20 mm	150	0,040	0,027
4427025	Ø25 mm	60	0,062	0,027
4427032	Ø32 mm	50	0,103	0,027



PPR-C (90°) UZUN DİRSEK / ELBOW LONG / ДЛИННЫЙ УГОЛЬНИК

CODE КОД	SIZE (Ø) РАЗМЕР	1 BOX QUANTITY ЕД. В 1 КОРОБКЕ	WEIGHT (kg) ВЕС ЗА ЕД.	BOX SIZE (m ³) РАЗМЕР КОРОБ.
4426925	Ø25 mm	120	0,040	0,027

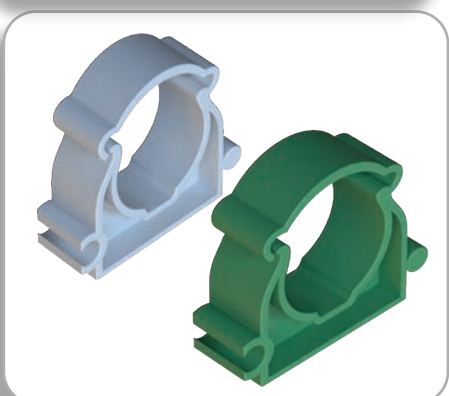

PPR-C KARAKLI KELEPÇE / SINGLE PIPE CLAMP CAP / ОПОРА С ЗАЩЕЛКОЙ

CODE КОД	SIZE (Ø) РАЗМЕР	1 BOX QUANTITY ЕД. В 1 КОРОБКЕ	WEIGHT (kg) ВЕС ЗА ЕД.	BOX SIZE (m ³) РАЗМЕР КОРОБ.
4422016	Ø16 mm	4000	0,005	0,096
4422020	Ø20 mm	2700	0,007	0,096
4422025	Ø25 mm	2000	0,007	0,096
4422032	Ø32 mm	1500	0,010	0,096
4422040	Ø40 mm	850	0,013	0,096
4422050	Ø50 mm	625	0,017	0,096

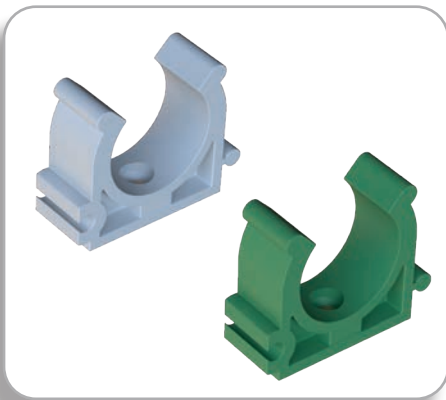

PPR-C AÇIK KELEPÇE / SINGLE PIPE CLAMP / ОПОРА

CODE КОД	SIZE (Ø) РАЗМЕР	1 BOX QUANTITY ЕД. В 1 КОРОБКЕ	WEIGHT (kg) ВЕС ЗА ЕД.	BOX SIZE (m ³) РАЗМЕР КОРОБ.
4424620	Ø20mm	4000	0,005	0,096
4424625	Ø25mm	3000	0,005	0,096
4424632	Ø32mm	2000	0,009	0,096

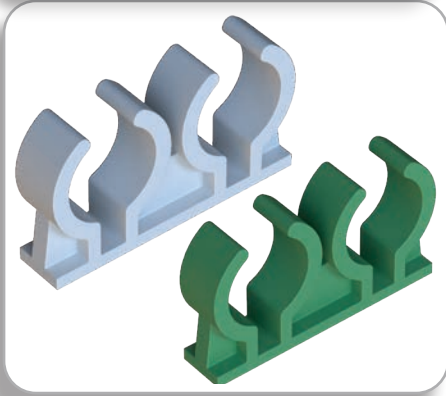

PPR-C ÇİFTLİ KELEPÇE / DOUBLE PIPE CLAMP / ДВОЙНАЯ ОПОРА

CODE КОД	SIZE (Ø) РАЗМЕР	1 BOX QUANTITY ЕД. В 1 КОРОБКЕ	WEIGHT (kg) ВЕС ЗА ЕД.	BOX SIZE (m ³) РАЗМЕР КОРОБ.
4422120	Ø20 mm	600	0,010	0,027
4422122	Ø22 mm	600	0,010	0,027
4422125	Ø25 mm	500	0,012	0,027
4422127	Ø27 mm	500	0,012	0,027
4422132	Ø32 mm	300	0,016	0,027



PPR-C ÇİFT TARAFLI PLASTİK OYNAR DOUBLE SIDED ADAPTOR PLS ПЛАСТИКОВАЯ РАЗЪЕМНАЯ МУФТА

CODE КОД	SIZE (Ø) РАЗМЕР	1 BOX QUANTITY ЕД. В 1 КОРОБКЕ	WEIGHT (kg) ВЕС ЗА ЕД.	BOX SIZE (m ³) РАЗМЕР КОРОБ.
4426620	Ø20 mm	150	0,035	0,027
4426625	Ø25 mm	150	0,041	0,027
4426632	Ø32 mm	80	0,061	0,027

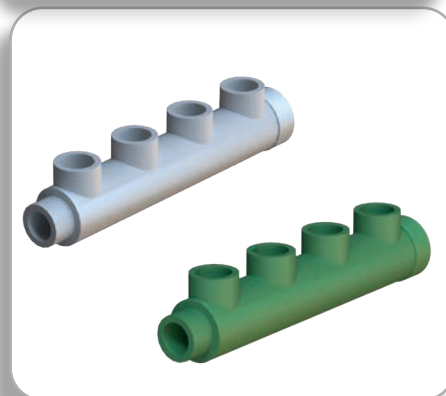

PPR-C MANİFOLD BORU / MANIFOLD PIPE / КОЛЛЕКТОРНАЯ ТРУБА

CODE КОД	SIZE (Ø) РАЗМЕР	1 BOX QUANTITY ЕД. В 1 КОРОБКЕ	WEIGHT (kg) ВЕС ЗА ЕД.	BOX SIZE (m ³) РАЗМЕР КОРОБ.
4428531	Ø32x20 mm	25	0,190	0,027
4428532	Ø32x25 mm	25	0,182	0,027
4428551	Ø50x25 mm	10	0,539	0,027
4428552	Ø50x32 mm	10	0,533	0,027



PPR-C İÇ DIŞLİ REKOR / FEMALE ROUND ADAPTER МУФТА КОМБИНИРОВАННАЯ С ВН./Р.

CODE КОД	SIZE (Ø) РАЗМЕР	1 BOX QUANTITY ЕД. В 1 КОРОБКЕ	WEIGHT (kg) ВЕС ЗА ЕД.	BOX SIZE (m ³) РАЗМЕР КОРОБ.
4421020	Ø20 x 1/2"	300	0,034	0,027
4421021	Ø20 x 3/4"	250	0,057	0,027
44E1022	Ø25 x 1/2"	300	0,040	0,027
4421022	Ø25 x 1/2" (LUX)	300	0,043	0,027
4421025	Ø25 x 3/4"	250	0,046	0,027
4421026	Ø32 x 1/2"	250	0,086	0,027
4421027	Ø32 x 3/4"	250	0,053	0,027
4421032	Ø32 x 1"	140	0,090	0,027

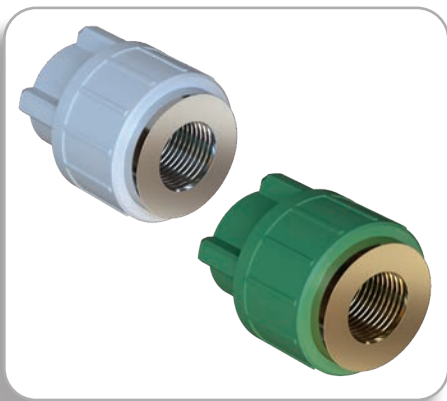

**PPR-C FUSION™ İÇ DİŞLİ REKOR
FUSION™ FEMALE ROUND ADAPTER
FUSION™ МУФТА КОМБИНИРОВАННАЯ
С ВН./Р.**

VALA

CODE КОД	SIZE (Ø) РАЗМЕР	1 BOX QUANTITY ЕД. В 1 КОРОБКЕ	WEIGHT (kg) ВЕС ЗА ЕД.	BOX SIZE (m³) РАЗМЕР КОРОБ.
4427620	Ø20 x 1/2" Fusion	200	0,066	0,027
4427622	Ø25 x 1/2" Fusion	200	0,080	0,027

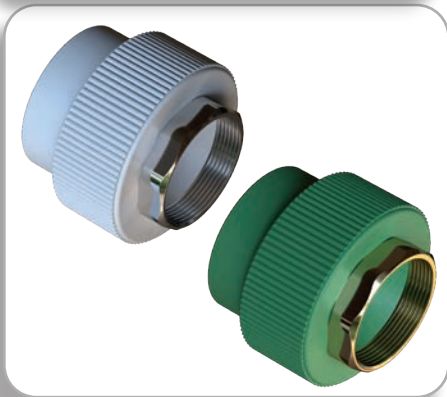

**PPR-C A.K. İÇ DİŞLİ REKOR / HEX. FEMALE ROUND
ADAPTER / МУФТА КОМБИНИРОВАННАЯ ПОД
КЛЮЧ С ВН./Р.**

CODE КОД	SIZE (Ø) РАЗМЕР	1 BOX QUANTITY ЕД. В 1 КОРОБКЕ	WEIGHT (kg) ВЕС ЗА ЕД.	BOX SIZE (m³) РАЗМЕР КОРОБ.
4421132	Ø32 x 1"	90	0,125	0,027
4421140	Ø40 x 1 1/4"	50	0,200	0,027
4421150	Ø50 x 1 1/2"	40	0,264	0,027
4421163	Ø63 x 2"	20	0,559	0,027
4421175	Ø75 x 2 1/2"	15	0,937	0,027
4421190	Ø90 x 3"	12	1,039	0,027



**PPR-C DİŞ DİŞLİ REKOR / MALE ROUND ADAPTER
МУФТА КОМБИНИРОВАННАЯ С НАР./Р.**

CODE КОД	SIZE (Ø) РАЗМЕР	1 BOX QUANTITY ЕД. В 1 КОРОБКЕ	WEIGHT (kg) ВЕС ЗА ЕД.	BOX SIZE (m³) РАЗМЕР КОРОБ.
4421220	Ø20 x 1/2"	300	0,044	0,027
4421221	Ø20 x 3/4"	200	0,060	0,027
44E1222	Ø25 x 1/2"	300	0,043	0,027
4421222	Ø25 x 1/2" (LUX)	300	0,048	0,027
4421225	Ø25 x 3/4"	200	0,061	0,027
4421226	Ø32 x 1/2"	200	0,092	0,027
4421227	Ø32 x 3/4"	200	0,064	0,027
4421232	Ø32 x 1"	120	0,098	0,027



**PPR-C FUSION™ DİŞ DİŞLİ REKOR
FUSION™ MALE ROUND ADAPTER
FUSION™ МУФТА КОМБИНИРОВАННАЯ С НАР./Р.**

CODE КОД	SIZE (Ø) РАЗМЕР	1 BOX QUANTITY ЕД. В 1 КОРОБКЕ	WEIGHT (kg) ВЕС ЗА ЕД.	BOX SIZE (m³) РАЗМЕР КОРОБ.
4427720	Ø20 x 1/2"	150	0,070	0,027
4427722	Ø25 x 1/2"	150	0,091	0,027



**PPR-C A.K. DİŞ DİŞLİ REKOR / HEX. MALE ROUND
ADAPTER / МУФТА КОМБИНИРОВАННАЯ ПОД
КЛЮЧ С НАР./Р.**

CODE КОД	SIZE (Ø) РАЗМЕР	1 BOX QUANTITY ЕД. В 1 КОРОБКЕ	WEIGHT (kg) ВЕС ЗА ЕД.	BOX SIZE (m³) РАЗМЕР КОРОБ.
4421332	Ø32 x 1"	100	0,120	0,027
4421340	Ø40 x 1 1/4"	50	0,285	0,027
4421350	Ø50 x 1 1/2"	35	0,344	0,027
4421363	Ø63 x 2"	25	0,558	0,027
4421375	Ø75 x 2 1/2"	12	0,876	0,027
4421390	Ø90 x 3"	10	1,076	0,027

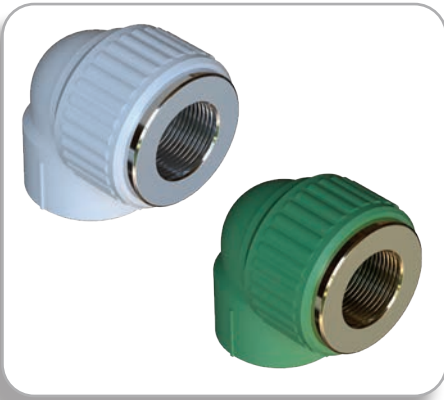

**PPR-C FUSION™ İÇ DIŞLİ DİRSEK
FUSION™ FEMALE ELBOW
FUSION™ УГОЛЬНИК КОМБИНИРОВАННЫЙ
ВН./Р.**

CODE КОД	SIZE (Ø) РАЗМЕР	1 BOX QUANTITY ЕД. В 1 КОРОБКЕ	WEIGHT (kg) ВЕС ЗА ЕД.	BOX SIZE (m³) РАЗМЕР КОРОБ.
4427820	Ø20 x 1/2"	175	0,061	0,027
4427822	Ø25 x 1/2"	150	0,077	0,027

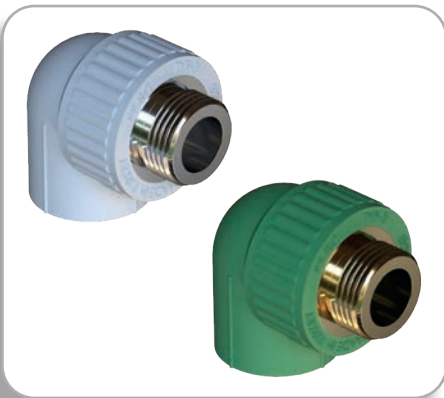

**PPR-C DIŞ DIŞLİ DİRSEK / MALE ELBOW
УГОЛЬНИК КОМБИНИРОВАННЫЙ НАР./Р.**

CODE КОД	SIZE (Ø) РАЗМЕР	1 BOX QUANTITY ЕД. В 1 КОРОБКЕ	WEIGHT (kg) ВЕС ЗА ЕД.	BOX SIZE (m³) РАЗМЕР КОРОБ.
4421520	Ø20 x 1/2"	250	0,050	0,027
4421521	Ø20 x 3/4"	150	0,102	0,027
44E1525	Ø25 x 1/2"	150	0,052	0,027
4421522	Ø25 x 1/2" (LUX)	150	0,066	0,027
4421525	Ø25 x 3/4"	150	0,078	0,027
4421526	Ø32 x 1/2"	80	0,110	0,027
4421527	Ø32 x 3/4"	80	0,145	0,027
4421532	Ø32 x 1"	80	0,109	0,027

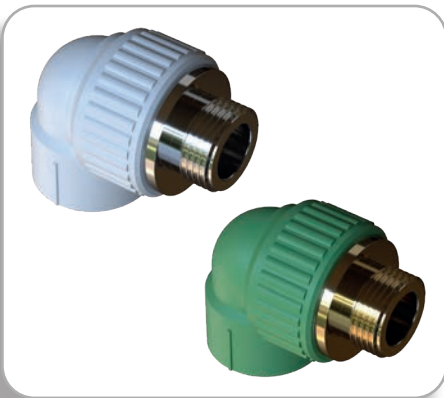

**PPR-C FUSION™ DIŞ DIŞLİ DİRSEK
FUSION™ MALE ELBOW
FUSION™ УГОЛЬНИК КОМБИНИРОВАННЫЙ
НАР./Р.**

CODE КОД	SIZE (Ø) РАЗМЕР	1 BOX QUANTITY ЕД. В 1 КОРОБКЕ	WEIGHT (kg) ВЕС ЗА ЕД.	BOX SIZE (m³) РАЗМЕР КОРОБ.
4427920	Ø20 x 1/2"	150	0,080	0,027
4427922	Ø25 x 1/2"	140	0,111	0,027



**PPR-C İÇ DIŞLİ TE / FEMALE TEE / ТРОЙНИК
КОМБИНИРОВАННЫЙ ВН./Р.**

CODE КОД	SIZE (Ø) РАЗМЕР	1 BOX QUANTITY ЕД. В 1 КОРОБКЕ	WEIGHT (kg) ВЕС ЗА ЕД.	BOX SIZE (m³) РАЗМЕР КОРОБ.
4421620	Ø20 x 1/2"	175	0,051	0,027
4421621	Ø20 x 3/4"	100	0,067	0,027
44E1622	Ø25 x 1/2"	150	0,051	0,027
4421622	Ø25 x 1/2" (LUX)	100	0,065	0,027
4421625	Ø25 x 3/4"	100	0,080	0,027
4421626	Ø32 x 1/2"	80	0,116	0,027
4421627	Ø32 x 3/4"	70	0,118	0,027
4421632	Ø32 x 1"	70	0,995	0,027

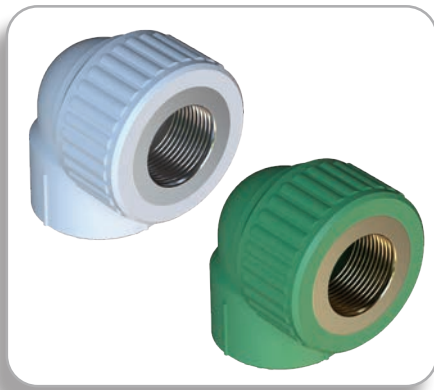

PPR-C İÇ DİŞLİ DİRSEK / FEMALE ELBOW УГОЛЬНИК КОМБИНИРОВАННЫЙ ВН./Р.

CODE КОД	SIZE (Ø) РАЗМЕР	1 BOX QUANTITY ЕД. В 1 КОРОБКЕ	WEIGHT (kg) ВЕС ЗА ЕД.	BOX SIZE (m ³) РАЗМЕР КОРОБ.
4421420	Ø20 x 1/2"	300	0,054	0,027
4421421	Ø20 x 3/4"	175	0,080	0,027
44E1422	Ø25 x 1/2"	200	0,047	0,027
4421422	Ø25 x 1/2" (LUX)	175	0,056	0,027
4421425	Ø25 x 3/4"	175	0,078	0,027
4421426	Ø32 x 1/2"	100	0,095	0,027
4421427	Ø32 x 3/4"	100	0,095	0,027
4421432	Ø32 x 1"	100	0,094	0,027

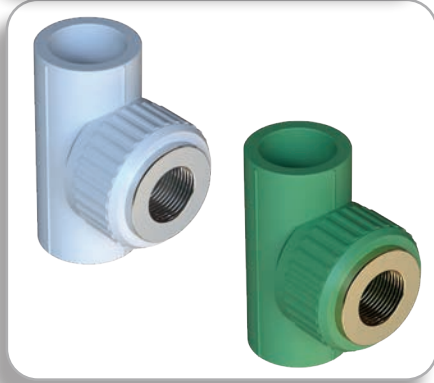

PPR-C FUSION™ İÇ DİŞLİ TE / FUSION™ FEMALE TEE FUSION™ ТРОЙНИК КОМБИНИРОВАННЫЙ ВН./Р.

CODE КОД	SIZE (Ø) РАЗМЕР	1 BOX QUANTITY ЕД. В 1 КОРОБКЕ	WEIGHT (kg) ВЕС ЗА ЕД.	BOX SIZE (m ³) РАЗМЕР КОРОБ.
4428020	Ø20 x 1/2"	150	0,071	0,027
4428022	Ø25 x 1/2"	100	0,101	0,027

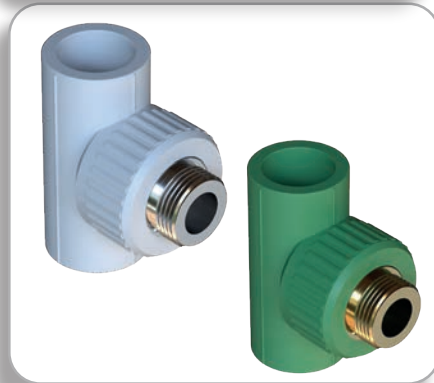

PPR-C DİŞ DİŞLİ TE / MALE TEE ТРОЙНИК КОМБИНИРОВАННЫЙ НАР./Р.

CODE КОД	SIZE (Ø) РАЗМЕР	1 BOX QUANTITY ЕД. В 1 КОРОБКЕ	WEIGHT (kg) ВЕС ЗА ЕД.	BOX SIZE (m ³) РАЗМЕР КОРОБ.
4421720	Ø20 x 1/2"	150	0,077	0,027
4421721	Ø20 x 3/4"	100	0,103	0,027
44E1722	Ø25 x 1/2"	150	0,056	0,027
4421722	Ø25 x 1/2" (LUX)	100	0,112	0,027
4421725	Ø25 x 3/4"	100	0,100	0,027
4421726	Ø32 x 1/2"	70	0,135	0,027
4421727	Ø32 x 3/4"	70	0,140	0,027
4421732	Ø32 x 1"	50	0,162	0,027



PPR-C FUSION™ DİŞ DİŞLİ TE / FUSION™ MALE TEE FUSION™ ТРОЙНИК КОМБИНИРОВАННЫЙ НАР./Р.

CODE КОД	SIZE (Ø) РАЗМЕР	1 BOX QUANTITY ЕД. В 1 КОРОБКЕ	WEIGHT (kg) ВЕС ЗА ЕД.	BOX SIZE (m ³) РАЗМЕР КОРОБ.
4428120	Ø20 x 1/2"	125	0,090	0,027
4428122	Ø25 x 1/2"	100	0,140	0,027



PPR-C OYNAR BAŞLIKLİ İÇ DİŞLİ RAKOR / FEMALE HEX. CONNECTION / МУФТА КОМБИНИРОВАННАЯ РАЗЪЕМНАЯ ВН.Р.

CODE КОД	SIZE (Ø) РАЗМЕР	1 BOX QUANTITY ЕД. В 1 КОРОБКЕ	WEIGHT (kg) ВЕС ЗА ЕД.	BOX SIZE (m ³) РАЗМЕР КОРОБ.
4422320	Ø20 x 1/2"	300	0,061	0,027
4422325	Ø25 x 3/4"	200	0,096	0,027
4422332	Ø32 x 1"	160	0,114	0,027
4422340	Ø40 x 1 1/4"	90	0,180	0,027
4422350	Ø50 x 1 1/2"	50	0,341	0,027
4422363	Ø63 x 2"	25	0,602	0,027
4422375	Ø75 x 2 1/2"	18	0,963	0,027
4422390	Ø90 x 3"	10	1,701	0,027

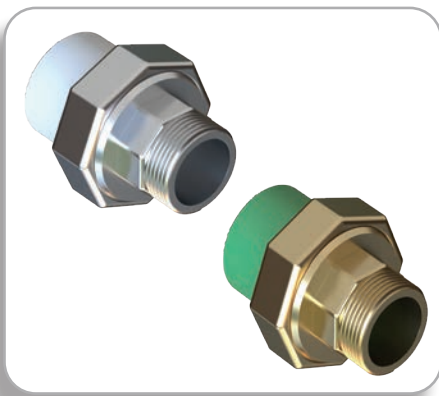

PPR-C OYNAR BAŞLIKLİ DIŞ DIŞLİ RAKOR

MALE HEX. CONNECTION / МУФТА

КОМБИНИРОВАННАЯ РАЗЪЕМНАЯ НАР.Р.

VALA

CODE КОД	SIZE (Ø) РАЗМЕР	1 BOX QUANTITY ЕД. В 1 КОРОБКЕ	WEIGHT (kg) ВЕС ЗА ЕД.	BOX SIZE (m ³) РАЗМЕР КОРОБ.
4422420	Ø20 x 1/2"	300	0,069	0,027
4422425	Ø25 x 3/4"	200	0,106	0,027
4422432	Ø32 x 1"	120	0,124	0,027
4422440	Ø40 x 1 1/4"	70	0,208	0,027
4422450	Ø50 x 1 1/2"	50	0,360	0,027
4422463	Ø63 x 2"	32	0,760	0,027
4422475	Ø75 x 2 1/2"	12	0,960	0,027
4422490	Ø90 x 3"	7	1,950	0,027

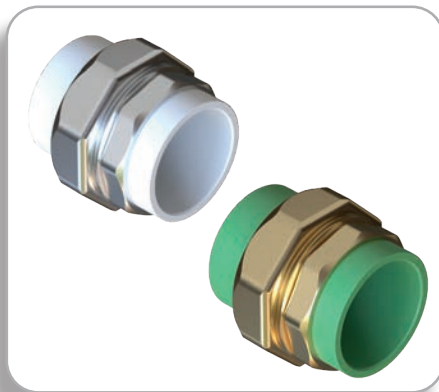

PPR-C ÇİFT TARAFLI OYNAR BAŞLIKLİ RAKOR / DOUBLE SIDED ADAPTOR / ДВОЙНАЯ РАЗЪЕМНАЯ МУФТА

CODE КОД	SIZE (Ø) РАЗМЕР	1 BOX QUANTITY ЕД. В 1 КОРОБКЕ	WEIGHT (kg) ВЕС ЗА ЕД.	BOX SIZE (m ³) РАЗМЕР КОРОБ.
4422620	Ø20 mm	180	0,950	0,027
4422625	Ø25 mm	140	0,115	0,027
4422632	Ø32 mm	100	0,172	0,027
4422640	Ø40 mm	80	0,268	0,027
4422650	Ø50 mm	50	0,396	0,027
4422663	Ø63 mm	25	0,610	0,027

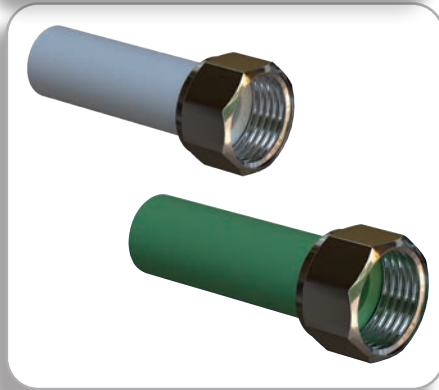

PPR-C SU SAYACI ADAPTÖRÜ / WATER METER ADAPTOR / ДВОЙНАЯ РАЗЪЕМНАЯ МУФТА

CODE КОД	SIZE (Ø) РАЗМЕР	1 BOX QUANTITY ЕД. В 1 КОРОБКЕ	WEIGHT (kg) ВЕС ЗА ЕД.	BOX SIZE (m ³) РАЗМЕР КОРОБ.
4428625	Ø25x1 mm	140	0,200	0,027

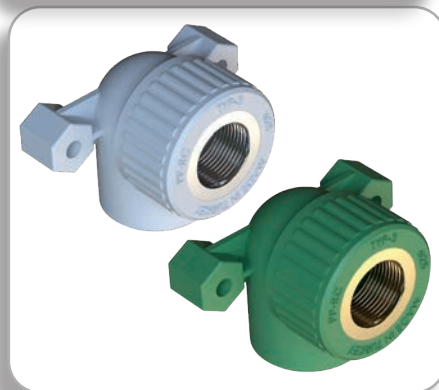

PPR-C TEKLİ BATARYA BAĞ. / FEMALE BATTERY CONN. PIECE / УГОЛЬНИК КОМ. С КРЕПЛЕНИЕМ В/Р.

CODE КОД	SIZE (Ø) РАЗМЕР	1 BOX QUANTITY ЕД. В 1 КОРОБКЕ	WEIGHT (kg) ВЕС ЗА ЕД.	BOX SIZE (m ³) РАЗМЕР КОРОБ.
4420620	Ø20 x 1/2"	140	0,054	0,027
4420621	Ø20 x 1/2" DD	120	0,078	0,027
4420622	Ø25 x 1/2"	140	0,068	0,027
4420625	Ø25 x 3/4"	120	0,075	0,027

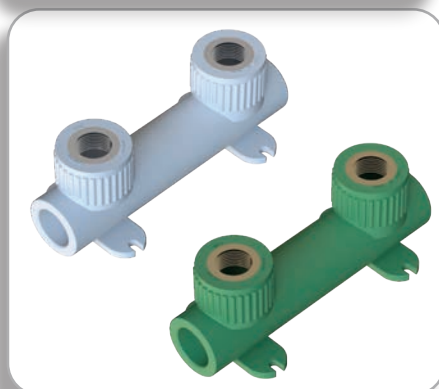

PPR-C İÇ DIŞLİ TAHARAT BATARYASI (10,5cm) FEMALE WC BATTERY CONNECTION / НАСТЕННЫЙ КОМПЛЕКТ ДЛЯ ГИБКОЙ ПОДВОДКИ

CODE КОД	SIZE (Ø) РАЗМЕР	1 BOX QUANTITY ЕД. В 1 КОРОБКЕ	WEIGHT (kg) ВЕС ЗА ЕД.	BOX SIZE (m ³) РАЗМЕР КОРОБ.
4424920	Ø20 x 1/2"	80	0,108	0,027

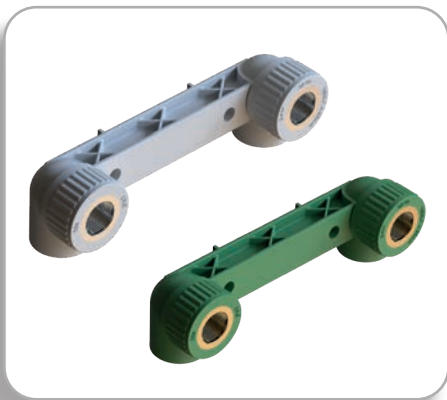

**PPR-C (15,5cm) SABİT BATARYA BAĞ. İÇ DİŞ
FEMALE DOUBLE BATTERY CON. /
НАСТЕННЫЙ КОМПЛЕКТ ДЛЯ СМЕСИТЕЛЯ ВН./Р.**

CODE КОД	SIZE (Ø) РАЗМЕР	1 BOX QUANTITY ЕД. В 1 КОРОБКЕ	WEIGHT (kg) ВЕС ЗА ЕД.	BOX SIZE (m ³) РАЗМЕР КОРОБ.
4424120	Ø20x1/2"	50	-	0,027
4424122	Ø25x1/2"	50	-	0,027



**PPR-C (15,5cm) FUSION™ SABİT BATARYA BAĞ. İÇ DİŞ
FUSION™ FEMALE DOUBLE BATTERY CON.
FUSION™ НАСТЕННЫЙ КОМПЛЕКТ ДЛЯ
СМЕСИТЕЛЯ ВН./Р.**

CODE КОД	SIZE (Ø) РАЗМЕР	1 BOX QUANTITY ЕД. В 1 КОРОБКЕ	WEIGHT (kg) ВЕС ЗА ЕД.	BOX SIZE (m ³) РАЗМЕР КОРОБ.
4428620	Ø20x1/2"	50	0,181	0,032
4428622	Ø25x1/2"	50	0,175	0,032



**PPR-C (15,5cm) SABİT BATARYA BAĞ. DIŞ DİŞ
MALE DOUBLE BATTERY CON. / НАСТЕННЫЙ
КОМПЛЕКТ ДЛЯ СМЕСИТЕЛЯ НАР./Р.**

CODE КОД	SIZE (Ø) РАЗМЕР	1 BOX QUANTITY ЕД. В 1 КОРОБКЕ	WEIGHT (kg) ВЕС ЗА ЕД.	BOX SIZE (m ³) РАЗМЕР КОРОБ.
4426820	Ø20x1/2"	50	0,142	0,027
4426822	Ø25x1/2"	50	-	0,027

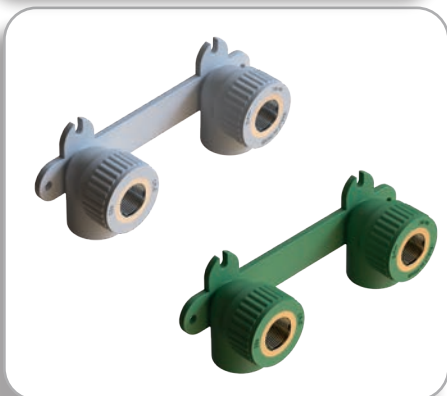

**PPR-C (10,5cm) KISA SABİT BATARYA BAĞ.
FEMALE DOUBLE BATTERY CON. / НАСТЕННЫЙ
КОМПЛЕКТ ДЛЯ СМЕСИТЕЛЯ КОРОТКИЙ**

CODE КОД	SIZE (Ø) РАЗМЕР	1 BOX QUANTITY ЕД. В 1 КОРОБКЕ	WEIGHT (kg) ВЕС ЗА ЕД.	BOX SIZE (m ³) РАЗМЕР КОРОБ.
4425520	Ø20x1/2"	60	0,125	0,032
4425522	Ø25x1/2"	60	0,125	0,032



**PPR- C AYARLI BATARYA BAĞLANTISI / ADJUST-
ABLE BATTERY CONNECTION / УНИВЕРСАЛЬНЫЙ
НАСТЕННЫЙ КОМПЛЕКТ**

CODE КОД	SIZE (Ø) РАЗМЕР	1 BOX QUANTITY ЕД. В 1 КОРОБКЕ	WEIGHT (kg) ВЕС ЗА ЕД.	BOX SIZE (m ³) РАЗМЕР КОРОБ.
4423120	Ø20x1/2"	50	0,125	0,027
4423122	Ø25x1/2"	50	0,121	0,027

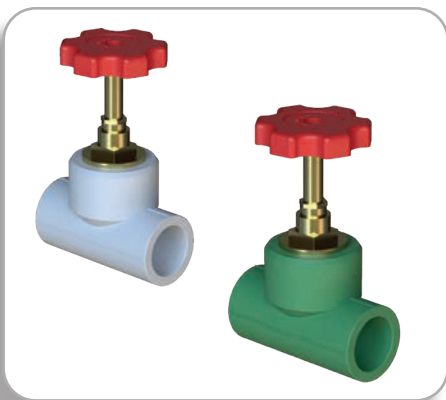

PPR-C KELEBEK VANA / STOP VALVE / ВЕНТИЛЬ

CODE КОД	SIZE (Ø) РАЗМЕР	1 BOX QUANTITY ЕД. В 1 КОРОБКЕ	WEIGHT (kg) ВЕС ЗА ЕД.	BOX SIZE (m ³) РАЗМЕР КОРОБ.
4421820	Ø20 mm	80	0,127	0,027
4421821	Ø20x3/4 mm	60	0,185	0,027
4421825	Ø25 mm	60	0,161	0,027
4421832	Ø32 mm	40	0,245	0,027
4421840	Ø40 mm	30	0,307	0,027
4421850	Ø50 mm	25	0,334	0,027
4421863	Ø63 mm	16	0,456	0,027

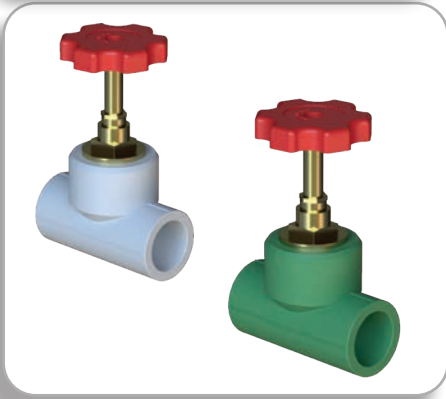

PPR-C METAL BAŞLI KELEBEK VANA / STOP VALVE WITH METAL HEAD / ЗАПОРНЫЙ КЛАПАН С МЕТАЛЛИЧЕСКОЙ ГОЛОВКОЙ

CODE КОД	SIZE (Ø) РАЗМЕР	1 BOX QUANTITY ЕД. В 1 КОРОБКЕ	WEIGHT (kg) ВЕС ЗА ЕД.	BOX SIZE (m ³) РАЗМЕР КОРОБ.
4429120	Ø20 mm	80	0,137	0,027
4429121	Ø20x3/4 mm	60	0,195	0,027
4429125	Ø25 mm	60	0,171	0,027
4429132	Ø32 mm	40	0,255	0,027
4429140	Ø40 mm	30	0,317	0,027
4429150	Ø50 mm	25	0,344	0,027
4429163	Ø63 mm	16	0,466	0,027



PPR-C KROMLU EKO LÜKS VANA / CHROME ECO VALVE LUX / ВЕНТИЛЬ ХРОМИРОВАННЫЙ

CODE КОД	SIZE (Ø) РАЗМЕР	1 BOX QUANTITY ЕД. В 1 КОРОБКЕ	WEIGHT (kg) ВЕС ЗА ЕД.	BOX SIZE (m ³) РАЗМЕР КОРОБ.
4421920	Ø20 mm	50	0,317	0,027
4421925	Ø25 mm	50	0,340	0,027
4421932	Ø32 mm	40	0,380	0,027



PPR-C KROMLU LÜKS VANA / CHROME VALVE LUX / ВЕНТИЛЬ ХРОМИРОВАННЫЙ

CODE КОД	SIZE (Ø) РАЗМЕР	1 BOX QUANTITY ЕД. В 1 КОРОБКЕ	WEIGHT (kg) ВЕС ЗА ЕД.	BOX SIZE (m ³) РАЗМЕР КОРОБ.
4427120	Ø20 mm	50	0,317	0,027
4427125	Ø25 mm	50	0,313	0,027
4427132	Ø32 mm	40	0,380	0,027



PPR-C KROMLU DELÜKS VANA / CHROME VALVE DELUX / ВЕНТИЛЬ ХРОМИРОВАННЫЙ

CODE КОД	SIZE (Ø) РАЗМЕР	1 BOX QUANTITY ЕД. В 1 КОРОБКЕ	WEIGHT (kg) ВЕС ЗА ЕД.	BOX SIZE (m ³) РАЗМЕР КОРОБ.
4427220	Ø20 mm	50	0,317	0,027
4427225	Ø25 mm	40	0,344	0,027
4427232	Ø32 mm	30	0,380	0,027

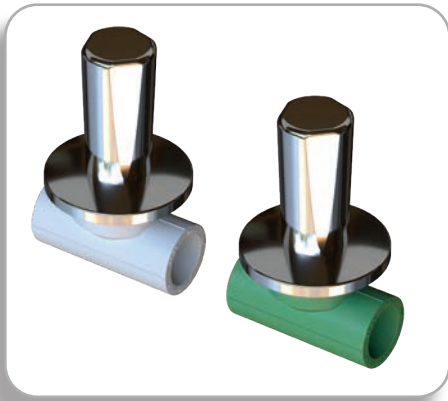

PPR-C KROMLU GİZLİ LÜKS VANA / CHROME HIDDEN VALVE LUX / ВЕНТИЛЬ ХРОМИРОВАННЫЙ

CODE КОД	SIZE (Ø) РАЗМЕР	1 BOX QUANTITY ЕД. В 1 КОРОБКЕ	WEIGHT (kg) ВЕС ЗА ЕД.	BOX SIZE (m ³) РАЗМЕР КОРОБ.
4427320	Ø20 mm	50	0,317	0,027
4427325	Ø25 mm	50	0,340	0,027
4427332	Ø32 mm	30	0,380	0,027

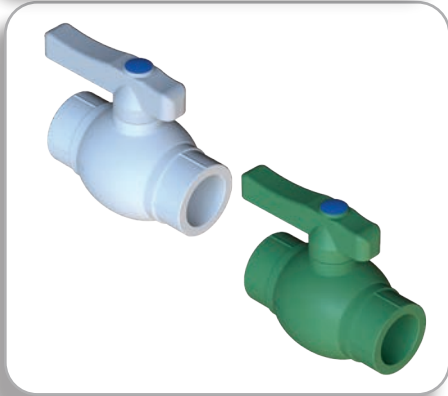

PPR-C KÜRESEL VANA / BALL VALVE / ШАРОВОЙ КРАН

CODE КОД	SIZE (Ø) РАЗМЕР	1 BOX QUANTITY ЕД. В 1 КОРОБКЕ	WEIGHT (kg) ВЕС ЗА ЕД.	BOX SIZE (m ³) РАЗМЕР КОРОБ.
4422520	Ø20 mm	100	0,097	0,027
4422525	Ø25 mm	70	0,118	0,027
4422532	Ø32 mm	45	0,188	0,027
4422540	Ø40 mm	20	0,362	0,027
4422550	Ø50 mm	20	0,500	0,027
4422563	Ø63 mm	10	0,775	0,027
4422575	Ø75 mm	5	1,118	0,027
4422590	Ø90 mm	0	-	0,027

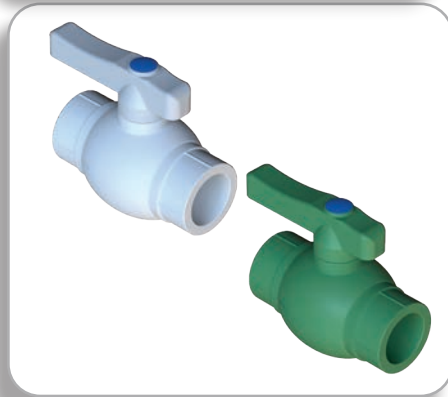

PPR-C ECO. KÜRESEL VANA / BALL VALVE ECO. АЛ. ШАРОВОЙ КРАН

CODE КОД	SIZE (Ø) РАЗМЕР	1 BOX QUANTITY ЕД. В 1 КОРОБКЕ	WEIGHT (kg) ВЕС ЗА ЕД.	BOX SIZE (m ³) РАЗМЕР КОРОБ.
44A2520	Ø20 mm	100	0,097	0,027
44A2525	Ø25 mm	80	0,118	0,027
44A2532	Ø32 mm	50	0,188	0,027
44A2540	Ø40 mm	20	0,048	0,027

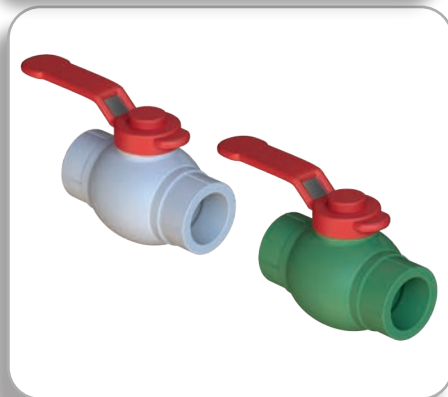

PPR-C METAL SAPLI KÜRESEL VANA / BALL VALVE WITH METAL HANDLE / АЛ. ШАРОВОЙ КРАН

CODE КОД	SIZE (Ø) РАЗМЕР	1 BOX QUANTITY ЕД. В 1 КОРОБКЕ	WEIGHT (kg) ВЕС ЗА ЕД.	BOX SIZE (m ³) РАЗМЕР КОРОБ.
4429320	Ø20 mm	70	0,074	0,027
4429325	Ø25 mm	45	0,110	0,027
4429332	Ø32 mm	18	-	0,027

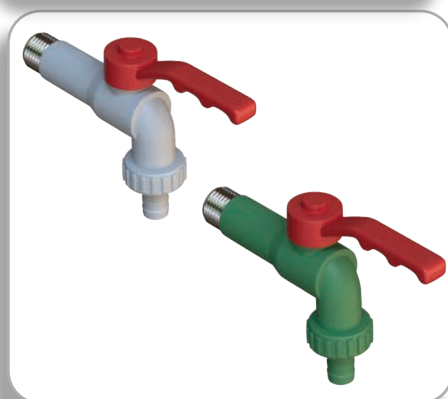

PPR-C KÜRESEL VANA MUSLUĞU / BALL VALVE TAP / АЛ. ШАРОВОЙ КРАН

CODE КОД	SIZE (Ø) РАЗМЕР	1 BOX QUANTITY ЕД. В 1 КОРОБКЕ	WEIGHT (kg) ВЕС ЗА ЕД.	BOX SIZE (m ³) РАЗМЕР КОРОБ.
4428420	Ø20 mm	80	-	0,027

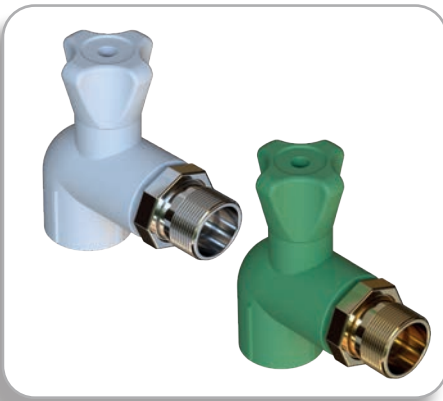

PPR-C KÖŞE RADYATÖR VANASI / BALL RADIATOR VALVE ELBOW / ШАРОВОЙ КРАН ДЛЯ РАДИАТОРА УГОЛЬНИК

CODE КОД	SIZE (Ø) РАЗМЕР	1 BOX QUANTITY ЕД. В 1 КОРОБКЕ	WEIGHT (kg) ВЕС ЗА ЕД.	BOX SIZE (m ³) РАЗМЕР КОРОБ.
4423420	Ø20x1/2"	100	0,160	0,027
4423425	Ø25x3/4"	80	0,215	0,027



PPR-C RADYATÖR VANASI DÜZ / BALL RADIATOR VALVE STRAIGHT / ШАРОВОЙ КРАН ДЛЯ РАДИАТОРА ПРЯМОЙ

CODE КОД	SIZE (Ø) РАЗМЕР	1 BOX QUANTITY ЕД. В 1 КОРОБКЕ	WEIGHT (kg) ВЕС ЗА ЕД.	BOX SIZE (m ³) РАЗМЕР КОРОБ.
4423520	Ø20x1/2"	80	0,196	0,027
4423525	Ø25x3/4"	80	0,210	0,027

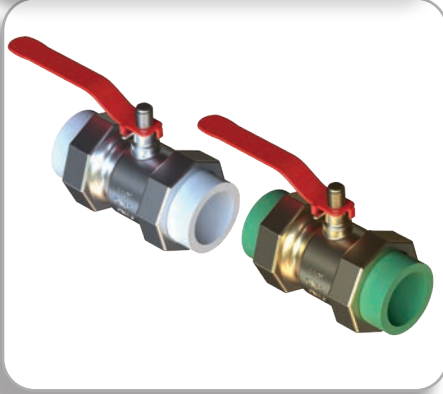

PPR-C METAL KÜRESEL VANA PLASTİK FLANŞ BAĞ. / METAL BALL VALVE WITH FLANGE / МЕТАЛЛИЧЕСКИЙ ШАРОВОЙ КРАН С ФЛАНЦОМ

CODE КОД	SIZE (Ø) РАЗМЕР	1 BOX QUANTITY ЕД. В 1 КОРОБКЕ	WEIGHT (kg) ВЕС ЗА ЕД.	BOX SIZE (m ³) РАЗМЕР КОРОБ.
4427420	Ø20 mm	-	0,232	0,027
4427425	Ø25 mm	50	0,378	0,027
4427432	Ø32 mm	40	0,492	0,027
4427440	Ø40 mm	25	0,848	0,027
4427450	Ø50 mm	15	1,200	0,027
4427463	Ø63 mm	10	1,600	0,027



PPR-C DELİKLİ DUŞ BATARYASI / HOLE SHOWER BATTERY / ОТВЕРСТИЕ ДУШЕВАЯ БАТАРЕЯ

CODE КОД	SIZE (Ø) РАЗМЕР	1 BOX QUANTITY ЕД. В 1 КОРОБКЕ	WEIGHT (kg) ВЕС ЗА ЕД.	BOX SIZE (m ³) РАЗМЕР КОРОБ.
4428725	Ø25 mm	-	0,330	0,027



PPR-C LÜX METAL VANA / LUX METAL VALVE / ЛЮКС МЕТАЛЛИЧЕСКИЙ КЛАПАН

CODE КОД	SIZE (Ø) РАЗМЕР	1 BOX QUANTITY ЕД. В 1 КОРОБКЕ	WEIGHT (kg) ВЕС ЗА ЕД.	BOX SIZE (m ³) РАЗМЕР КОРОБ.
4428820	Ø20 mm	-	0,232	0,022
4428825	Ø25 mm	-	0,232	0,022

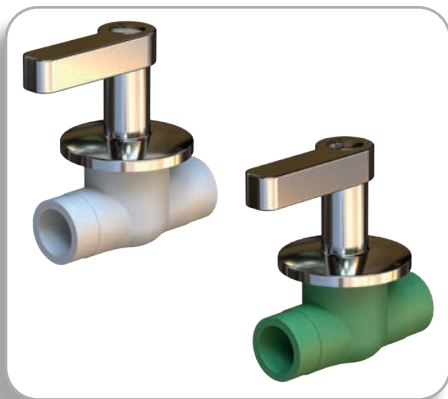

PPR-C LÜX PİRİNÇ VANA / LUX BRASS VALVE / ЛАТУННЫЙ КЛАПАН ЛЮКС

CODE КОД	SIZE (Ø) РАЗМЕР	1 BOX QUANTITY ЕД. В 1 КОРОБКЕ	WEIGHT (kg) ВЕС ЗА ЕД.	BOX SIZE (m ³) РАЗМЕР КОРОБ.
4429025	Ø25 mm	-	0,325	0,027
4429032	Ø32 mm	-	-	0,027



PPR-C İÇ DİŞLİ İNEGAL T TEKLİ / ÇİFTLİ / FEMALE REDUCTION TEE PIECE / DOUBLE / ТРОЙНИК ПЕРЕХОДНОЙ ВН.Р.

CODE КОД	SIZE (Ø) РАЗМЕР	1 BOX QUANTITY ЕД. В 1 КОРОБКЕ	WEIGHT (kg) ВЕС ЗА ЕД.	BOX SIZE (m ³) РАЗМЕР КОРОБ.
4424240	Ø40x3 / 4x40 mm	-	0,360	0,027
4424340			0,393	
4424250	Ø50x3 / 4x50 mm	-	0,310	0,027
4424350			0,338	
4424263	Ø63x3 / 4x63 mm	-	0,245	0,027
4424363			0,272	



PPR-C HAKARETLİ REKOR /ADAPTER WITH LOOSE NUT / МУФТА С НАКИДНОЙ ГАЙКОЙ

CODE КОД	SIZE (Ø) РАЗМЕР	1 BOX QUANTITY ЕД. В 1 КОРОБКЕ	WEIGHT (kg) ВЕС ЗА ЕД.	BOX SIZE (m ³) РАЗМЕР КОРОБ.
4424720	Ø20 x 1/2"	350	0,040	0,027
4424725	Ø25 x 3/4"	150	0,056	0,027
4424732	Ø32 x 1"	100	0,104	0,027



PPR-C HAKARETLİ DİRSEK / ELBOW WITH LOOSE NUT УГОЛЬНИК С НАКИДНОЙ ГАЙКОЙ

CODE КОД	SIZE (Ø) РАЗМЕР	1 BOX QUANTITY ЕД. В 1 КОРОБКЕ	WEIGHT (kg) ВЕС ЗА ЕД.	BOX SIZE (m ³) РАЗМЕР КОРОБ.
4424820	Ø20 x 1/2"	250	0,054	0,027
4424825	Ø25 x 3/4"	150	0,065	0,027
4424832	Ø32 x 1"	100	0,110	0,027



PPR-C FİLTRE / MALE FILTER / ФИЛЬТР

CODE КОД	SIZE (Ø) РАЗМЕР	1 BOX QUANTITY ЕД. В 1 КОРОБКЕ	WEIGHT (kg) ВЕС ЗА ЕД.	BOX SIZE (m ³) РАЗМЕР КОРОБ.
4425020	Ø20 x 1/2"	150	0,087	0,027
4425025	Ø25 x 3/4"	100	0,130	0,027

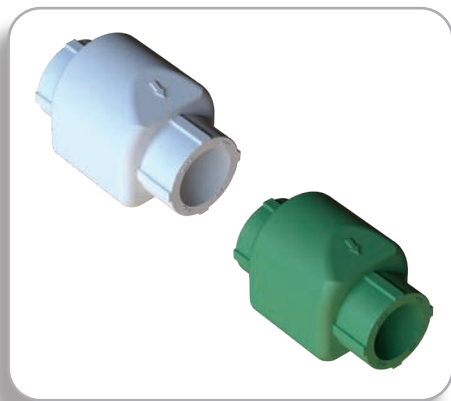

PPR-C ÇEKVALF / CHECK VALVE / ОБРАТНЫЙ КЛАПАН

CODE КОД	SIZE (Ø) РАЗМЕР	1 BOX QUANTITY ЕД. В 1 КОРОБКЕ	WEIGHT (kg) ВЕС ЗА ЕД.	BOX SIZE (m³) РАЗМЕР КОРОБ.
4426720	Ø20 mm	100	0,096	0,027
4426725	Ø25 mm	100	0,098	0,027
4426732	Ø32 mm	75	0,125	0,027



PPR-C KOMBİ BAĞLANTI SETİ / BOILER CONNECTION SET / СЕТ ДЛЯ КОМБИ

CODE КОД	SIZE (Ø) РАЗМЕР	1 BOX QUANTITY ЕД. В 1 КОРОБКЕ	WEIGHT (kg) ВЕС ЗА ЕД.	BOX SIZE (m³) РАЗМЕР КОРОБ.
4425620	Ø20mm - 25mm	1	0,485	0,010
4425625	Ø25mm - 25mm	1	0,500	0,010
4425632	Ø25mm - 25mm AL	1	0,500	0,010
4425640	Ø25mm - 25mm AL	1	0,500	0,010

PPR-C PIPE AND FITTINGS ACCESSORIES



PPR-C KAYNAK PAFTASI / WELDING KIT / НАСАДКА ДЛЯ СВАРОЧНЕГО ОПАРАТА

CODE КОД	SIZE (Ø) РАЗМЕР	1 BOX QUANTITY ЕД. В 1 КОРОБКЕ
6026316	Ø16 mm	1
6026320	Ø20 mm	1
6026325	Ø25 mm	1
6026332	Ø32 mm	1
6026340	Ø40 mm	1
6026350	Ø50 mm	1
6026363	Ø63 mm	1
6026375	Ø75 mm	1
6026390	Ø90 mm	1
6026311	Ø110 mm	1



KAYNAK MAKİNESİ / WELDING MACHINE / ЕСТ НАСОС С ЛАТУННЫМ ПОРШНЕМ

CODE КОД	SIZE (Ø) РАЗМЕР	1 BOX QUANTITY ЕД. В 1 КОРОБКЕ
6023020	Ø20 - Ø40 Eco	1
6023022	Ø20 - Ø40	1
6023025	Ø50 - Ø75	1



TEST POMPASI / TEST PUMP ТЕСТ НАСОС С ЛАТУННЫМ ПОРШНЕМ

CODE КОД	SIZE (Ø) РАЗМЕР	1 BOX QUANTITY ЕД. В 1 КОРОБКЕ
6026420	60bar	1

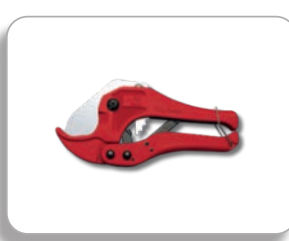

PPR-C KESME MAKASI / PIPE CUTTER НОЖНИЦА ДЛЯ РЕЗКИ ТРУБ

CODE КОД	SIZE (Ø) РАЗМЕР	1 BOX QUANTITY ЕД. В 1 КОРОБКЕ
6026520	Ø16mm - 42mm	1
6026521	Ø16mm - 42mm Auto	1
6026522	Ø40mm - 63mm	1



LASTIKLİ TRİFONLU KELEPÇE / CLAMP WITH TRIPHONE / ХОМУТ С ШПИЛЬКОЙ

CODE КОД	SIZE (Ø) РАЗМЕР	1 BOX QUANTITY ЕД. В 1 КОРОБКЕ	WEIGHT (kg) ВЕС ЗА ЕД.	BOX SIZE (m ³) РАЗМЕР КОРОБ.
60P1601	Ø3/8" (17-23)	400	0,046	0,026
60P1602	Ø1/2" (21-26)	400	0,049	0,026
60P1603	Ø3/4" (26-30)	350	0,062	0,026
60P1604	Ø1" (33-37)	300	0,077	0,026
60P1605	Ø1 1/4" (40-46)	200	0,082	0,026
60P1606	Ø1 1/2" (48-53)	175	0,088	0,026
60P1607	Ø2" (60-66)	125	0,090	0,026
60P1608	Ø2 1/2" (75-84)	100	0,188	0,026
60P1609	Ø3" (87-96)	90	0,220	0,026
60P1610	Ø3 1/2" (97-105)	75	0,220	0,026
60P1611	Ø4" (109-119)	60	0,250	0,026
60P1612	Ø5" (135-148)	40	0,300	0,026



LASTIKLİ SOMUNLU KELEPÇE CLAMP WITH NUTS / ХОМУТ С ГАЙКОЙ

CODE КОД	SIZE (Ø) РАЗМЕР	1 BOX QUANTITY ЕД. В 1 КОРОБКЕ	WEIGHT (kg) ВЕС ЗА ЕД.	BOX SIZE (m ³) РАЗМЕР КОРОБ.
60P1701	Ø3/8" (17-23)	600	0,048	0,026
60P1702	Ø1/2" (21-26)	600	0,050	0,026
60P1703	Ø3/4" (26-30)	500	0,049	0,026
60P1704	Ø1" (33-37)	400	0,058	0,026
60P1705	Ø1 1/4" (40-46)	250	0,066	0,026
60P1706	Ø1 1/2" (48-53)	225	0,061	0,026
60P1707	Ø2" (60-66)	150	0,091	0,026
60P1708	Ø2 1/2" (75-84)	120	0,179	0,026
60P1709	Ø3" (87-96)	100	0,225	0,026
60P1710	Ø3 1/2" (97-105)	100	0,248	0,026
60P1711	Ø4" (109-119)	100	0,267	0,026
60P1712	Ø4 1/2" (121-127)	100	0,296	0,026
60P1713	Ø5" (135-148)	75	0,246	0,026
60P1714	Ø5 1/2" (151-164)	75	0,282	0,026
60P1715	Ø6" (158-170)	75	0,320	0,026
60P1716	Ø7" (194-205)	75	0,328	0,026
60P1717	Ø8" (214-225)	50	0,348	0,026
60P1718	Ø10" (270-276)	40	0,360	0,026



LASTIKLİ SET KELEPÇE / CLAMP WITH SET ХОМУТ КОМПЛЕКТ

CODE КОД	SIZE (Ø) РАЗМЕР	1 BOX QUANTITY ЕД. В 1 КОРОБКЕ	WEIGHT (kg) ВЕС ЗА ЕД.	BOX SIZE (m ³) РАЗМЕР КОРОБ.
60P1801	Ø3/8" (17-23)	400	0,048	0,026
60P1802	Ø1/2" (21-26)	400	0,050	0,026
60P1803	Ø3/4" (26-30)	350	0,049	0,026
60P1804	Ø1" (33-37)	250	0,058	0,026
60P1805	Ø1 1/4" (40-46)	200	0,066	0,026
60P1806	Ø1 1/2" (48-53)	200	0,061	0,026
60P1807	Ø2" (60-66)	150	0,099	0,026
60P1808	Ø2 1/2" (75-84)	120	0,179	0,026
60P1809	Ø3" (87-96)	100	0,225	0,026
60P1810	Ø3 1/2" (97-105)	100	0,248	0,026
60P1811	Ø4" (109-119)	100	0,267	0,026
60P1812	Ø4 1/2" (121-127)	50	0,296	0,026
60P1813	Ø5" (135-148)	40	0,246	0,026
60P1814	Ø5 1/2" (151-164)	30	-	0,026
60P1815	Ø6" (158-170)	30	-	0,026
60P1816	Ø7" (194-205)	30	-	0,026
60P1817	Ø8" (214-225)	25	-	0,026
60P1818	Ø10" (270-276)	25	-	0,026



LASTIKLİ AĞIR YÜK KELEPÇESİ / WIDE HEAVY LOAD CLAMP / ХОМУТ ТЯЖЁЛОЙ НАГРУЗКИ

CODE КОД	SIZE (Ø) РАЗМЕР	1 BOX QUANTITY ЕД. В 1 КОРОБКЕ	WEIGHT (kg) ВЕС ЗА ЕД.	BOX SIZE (m ³) РАЗМЕР КОРОБ.
60P1901	Ø1/2" (21-26)	100	-	0,026
60P1902	Ø3/4" (26-30)	100	-	0,026
60P1903	Ø1" (33-37)	100	-	0,026
60P1904	Ø1 1/4" (40-46)	100	-	0,026
60P1905	Ø1 1/2" (48-53)	100	-	0,026
60P1906	Ø2" (60-66)	80	-	0,026
60P1907	Ø2 1/2" (60-66)	50	-	0,026
60P1908	Ø3" (87-96)	50	-	0,026
60P1909	Ø4" (109-119)	50	-	0,026
60P1910	Ø5" (135-148)	25	-	0,026
60P1911	Ø6" (158-170)	25	-	0,026
60P1912	Ø8" (214-225)	25	-	0,026
60P1913	Ø10" (270-276)	20	-	0,026

PVC PIPE AND FITTINGS



PVC ATIK SU BORUSU / WASTE WATER PIPE / ТРУБА КАНАЛИЗАЦИОННАЯ

CODE КОД	SIZE (Ø) РАЗМЕР	1 BOX QUANTITY ЕД. В 1 КОРОБКЕ	WEIGHT (kg) ВЕС ЗА ЕД.
60BOR01	Ø50 / 1000mm	5	0,826
60BOR02	Ø50 / 2000mm	5	1,606
60BOR03	Ø50 / 3000mm	5	2,386
60BOR04	Ø50 / 6000mm	1	4,726
60BOR05	Ø75 / 500mm	20	0,665
60BOR06	Ø75 / 1000mm	5	1,240
60BOR07	Ø75 / 2000mm	5	2,390
60BOR08	Ø75 / 3000mm	5	3,540
60BOR09	Ø75 / 6000mm	1	6,990
60BOR10	Ø110 / 150mm	35	0,403
60BOR11	Ø110 / 250mm	21	0,578
60BOR12	Ø110 / 500mm	10	1,016
60BOR13	Ø110 / 1000mm	3	1,891
60BOR14	Ø110 / 2000mm	3	3,641
60BOR15	Ø110 / 3000mm	3	5,391
60BOR16	Ø110 / 6000mm	1	10,64
60BOR17	Ø160 / 1000mm	1	3,409
60BOR18	Ø160 / 2000mm	1	6,459
60BOR19	Ø160 / 3000mm	1	9,509
60BOR20	Ø160 / 6000mm	1	18,650



PVC (45°) DİRSEK / ELBOW / УГОЛЬНИК

CODE КОД	SIZE (Ø) РАЗМЕР	1 BOX QUANTITY ЕД. В 1 КОРОБКЕ	WEIGHT (kg) ВЕС ЗА ЕД.
60D4501	45° Ø50mm	200	0,088
60D4502	45° Ø75mm	100	0,159
60D4503	45° Ø110mm	35	0,292
60D4504	45° Ø125mm	20	0,390
60D4505	45° Ø160mm	15	0,633
60D4506	45° Ø200mm	5	1,171
60D4507	45° Ø250mm	3	2,280

PVC (90°) DİRSEK / ELBOW / УГОЛЬНИК **VALA**



CODE КОД	SIZE (Ø) РАЗМЕР	1 BOX QUANTITY ЕД. В 1 КОРОБКЕ	WEIGHT (kg) ВЕС ЗА ЕД.
60D8701	87° Ø50mm	200	0,108
60D8702	87° Ø75mm	75	0,184
60D8703	87° Ø110mm	30	0,350
60D8704	45° Ø125mm	18	0,452
60D8705	87° Ø160mm	10	0,802
60D8706	45° Ø200mm	4	1,572
60D8707	45° Ø250mm	2	3,070



PVC (45°) ТЕК ÇATAL / BRANCH / ТРОЙНИК

CODE КОД	SIZE (Ø) РАЗМЕР	1 BOX QUANTITY ЕД. В 1 КОРОБКЕ	WEIGHT (kg) ВЕС ЗА ЕД.
60T4501	45° / Ø50 / Ø50 mm	100	0,170
60T4502	45° / Ø75 / Ø50 mm	50	0,233
60T4503	45° / Ø75 / Ø75 mm	45	0,320
60T4504	45° / Ø110 / Ø50 mm	20	0,394
60T4505	45° / Ø110 / Ø75 mm	15	0,479
60T4506	45° / Ø110 / Ø110 mm	15	0,637
60T4507	45° / Ø125 / Ø125 mm	12	0,835
60T4508	45° / Ø160 / Ø110 mm	5	1,117
60T4509	45° / Ø160 / Ø125 mm	10	1,256
60T4510	45° / Ø160 / Ø160 mm	4	1,681
60T4511	45° / Ø200 / Ø110 mm	5	1,610
60T4512	45° / Ø200 / Ø160 mm	4	1,992
60T4513	45° / Ø200 / Ø200 mm	2	2,586



PVC (90°) ТЕК ÇATAL / BRANCH / ТРОЙНИК

CODE КОД	SIZE (Ø) РАЗМЕР	1 BOX QUANTITY ЕД. В 1 КОРОБКЕ	WEIGHT (kg) ВЕС ЗА ЕД.
60T8701	87° / Ø50 / Ø50 mm	100	0,137
60T8702	87° / Ø75 / Ø50 mm	50	0,219
60T8703	87° / Ø75 / Ø75 mm	20	0,406
60T8704	87° / Ø110 / Ø50 mm	25	0,341
60T8705	87° / Ø110 / Ø75 mm	20	0,406
60T8706	87° / Ø110 / Ø110 mm	16	0,505
60T8707	87° / Ø125 / Ø125 mm	16	0,710
60T8708	87° / Ø160 / Ø110 mm	6	0,984
60T8709	87° / Ø160 / Ø125 mm	6	1,008
60T8710	87° / Ø160 / Ø160 mm	6	1,117
60T8711	87° / Ø200 / Ø110 mm	6	1,426
60T8712	87° / Ø200 / Ø160 mm	4	1,584
60T8713	87° / Ø200 / Ø200 mm	4	2,009



PVC (45°) ÇİFT ÇATAL / DOUBLE BRANCH / КРЕСТОВИНА

CODE КОД	SIZE (Ø) РАЗМЕР	1 BOX QUANTITY ЕД. В 1 КОРОБКЕ	WEIGHT (kg) ВЕС ЗА ЕД.
60DT451	45° / Ø50 / Ø50 mm	70	0,233
60DT452	45° / Ø75 / Ø50 mm	50	0,308
60DT453	45° / Ø75 / Ø75 mm	30	0,443
60DT454	45° / Ø110 / Ø50 mm	20	0,431
60DT455	45° / Ø110 / Ø75 mm	15	0,558
60DT456	45° / Ø110 / Ø110 mm	10	0,773
60DT457	45° / Ø125 / Ø125 mm	5	1,072



PVC (90°) ÇİFT ÇATAL / DUBLE BRANCH / КРЕСТОВИНА

CODE KOD	SIZE (Ø) РАЗМЕР	1 BOX QUANTITY ЕД. В 1 КОРОБКЕ	WEIGHT (kg) ВЕС ЗА ЕД.
60DT871	87° / Ø50 / Ø50 mm	70	0,192
60DT872	87° / Ø75 / Ø50 mm	50	0,262
60DT873	87° / Ø75 / Ø75 mm	30	0,330
60DT874	87° / Ø110 / Ø50 mm	20	0,358
60DT875	87° / Ø110 / Ø75 mm	15	0,474
60DT876	87° / Ø110 / Ø110 mm	10	0,604
60DT877	87° / Ø125 / Ø125 mm	5	0,716



PVC KAYAR MANŞON / SLIDING SOCKET / МУФТА СОЕДИНИТЕЛЬНАЯ

CODE KOD	SIZE (Ø) РАЗМЕР	1 BOX QUANTITY ЕД. В 1 КОРОБКЕ	WEIGHT (kg) ВЕС ЗА ЕД.
60MAN01	Ø50 mm	200	0,102
60MAN02	Ø75 mm	100	0,159
60MAN03	Ø110 mm	35	0,288
60MAN04	Ø125 mm	30	0,373
60MAN05	Ø160 mm	15	0,568
60MAN06	Ø200 mm	8	1,095
60MAN07	Ø250 mm	4	2,379



PVC REDÜKSİYON / REDUCTION / РЕДУКТОР

CODE KOD	SIZE (Ø) РАЗМЕР	1 BOX QUANTITY ЕД. В 1 КОРОБКЕ	WEIGHT (kg) ВЕС ЗА ЕД.
60RED01	Ø50 / Ø50 mm	150	0,114
60RED02	Ø110 / Ø50 mm	50	0,176
60RED03	Ø110 / Ø75 mm	70	0,202
60RED04	Ø125 / Ø75 mm	30	0,264
60RED05	Ø125 / Ø110 mm	30	0,264
60RED06	Ø160 / Ø75 mm	10	0,622
60RED07	Ø160 / Ø110 mm	20	0,516
60RED08	Ø160 / Ø125 mm	20	0,516
60RED09	Ø200 / Ø110 mm	10	0,622
60RED10	Ø200 / Ø125 mm	10	0,820
60RED11	Ø200 / Ø160 mm	10	0,729
60RED12	Ø250 / Ø160 mm	10	1,196



PVC MUF TAPASI / END CAP / ЗАГЛУШКА

CODE KOD	SIZE (Ø) РАЗМЕР	1 BOX QUANTITY ЕД. В 1 КОРОБКЕ	WEIGHT (kg) ВЕС ЗА ЕД.
60KAP01	Ø50 mm	200	500
60KAP02	Ø75 mm	100	400
60KAP03	Ø110 mm	35	150
60KAP04	Ø125 mm	30	100
60KAP05	Ø160 mm	15	80



PVC TEMİZLEME / CLEANING / РЕВИЗИЯ

CODE КОД	SIZE (Ø) РАЗМЕР	1 BOX QUANTITY ЕД. В 1 КОРОБКЕ	WEIGHT (kg) ВЕС ЗА ЕД.
60TEM01	Ø110 mm	16	0,571
60TEM02	Ø125 mm	16	0,740
60TEM03	Ø160 mm	6	1,222
60TEM04	Ø200 mm	4	1,901



PVC (45°) SIFON S / SIPHON ES / СИФОН S

CODE КОД	SIZE (Ø) РАЗМЕР	1 BOX QUANTITY ЕД. В 1 КОРОБКЕ	WEIGHT (kg) ВЕС ЗА ЕД.
60PES02	45°Ø110/ Ø110 mm	10	0,815



PVC (90°) SIFON S / SIPHON ES / СИФОН S

CODE КОД	SIZE (Ø) РАЗМЕР	1 BOX QUANTITY ЕД. В 1 КОРОБКЕ	WEIGHT (kg) ВЕС ЗА ЕД.
60PES03	87°Ø110/ Ø110 mm	10	0,815

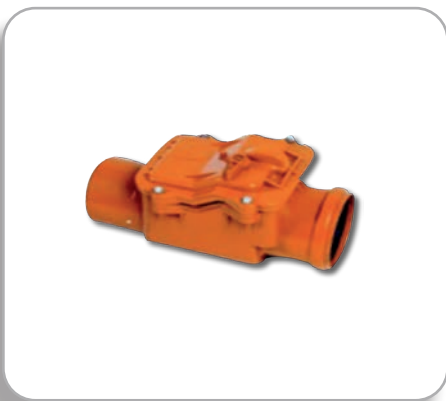

PVC ŞEKVALF / CHECK VALVE / ОБРАТНЫЙ КЛАПАН

CODE КОД	SIZE (Ø) РАЗМЕР	1 BOX QUANTITY ЕД. В 1 КОРОБКЕ	WEIGHT (kg) ВЕС ЗА ЕД.
60CEK01	Ø110 mm	1	1,048
60CEK02	Ø125 mm	1	1,049
60CEK03	Ø160 mm	1	1,047
60CEK04	Ø200 mm	1	3,518

**(180°) AYARLI TELLİ KADA / FLEXIBLE FOLDABLE TRAPE / СИФОН ДЛЯ УНИТАЗА**

CODE КОД	SIZE (Ø) РАЗМЕР	1 BOX QUANTITY ЕД. В 1 КОРОБКЕ	WEIGHT (kg) ВЕС ЗА ЕД.
60KAD01	180°Ø110mm	30	0,399

**PEX BORU / PEX TIG PIPE
ПЕХ ТРУБА**

CODE КОД	SIZE (Ø) РАЗМЕР	1 BOX QUANTITY ЕД. В 1 КОРОБКЕ	WEIGHT (kg) ВЕС ЗА ЕД.
60PEX01	Ø16mm-2.0mm	100 m	-
60PEX02	Ø20mm-2.0mm	100 m	-

**(90°) AYARLI TELLİ KADA DİRSEK / FLEXIBLE FOLDABLE TRAPE / СИФОН ДЛЯ УНИТАЗА**

CODE КОД	SIZE (Ø) РАЗМЕР	1 BOX QUANTITY ЕД. В 1 КОРОБКЕ	WEIGHT (kg) ВЕС ЗА ЕД.
60KAD02	90°Ø110mm	20	0,395

**PEX OKSİJEN BARIYERLİ / PEX OXYGEN BARRIER
ПЕХ КИСЛОРОДНЫЙ БАРЬЕР**

CODE КОД	SIZE (Ø) РАЗМЕР	1 BOX QUANTITY ЕД. В 1 КОРОБКЕ	WEIGHT (kg) ВЕС ЗА ЕД.
60PEX03	Ø16mm-2.0mm	100 m	-
60PEX04	Ø20mm-2.0mm	100 m	-

**DÜZ UZATMALI KADA CONTALI
CONNECTS TRAP WC ELASTIC
ДЛИННЫЙ ДОПОЛНИТЕЛЬНЫЙ СИФОН С РЕЗИНОЙ**

CODE КОД	SIZE (Ø) РАЗМЕР	1 BOX QUANTITY ЕД. В 1 КОРОБКЕ	WEIGHT (kg) ВЕС ЗА ЕД.
60KAD03	Ø110mm	30	0,318

**PEX KILIFLI / PEX WITH COVER BLUE & RED
ПЕХ С КРЫШКОЙ СИНИЙ И КРАСНЫЙ**

CODE КОД	SIZE (Ø) РАЗМЕР	1 BOX QUANTITY ЕД. В 1 КОРОБКЕ	WEIGHT (kg) ВЕС ЗА ЕД.
60PEX05	Ø16mm-2.0mm	100 m	-
60PEX06	Ø20mm-2.0mm	100 m	-

**EKSANTRİK DÜZ KADA
OFFSET RIGID WC CONNECTOR STRAIGHT
ПРЯМОЙ ДОПОЛНИТЕЛЬНЫЙ СИФОН**

CODE КОД	SIZE (Ø) РАЗМЕР	1 BOX QUANTITY ЕД. В 1 КОРОБКЕ	WEIGHT (kg) ВЕС ЗА ЕД.
60KAD05	Ø110mm	40	0,242

**PEX AL PEX BORU / AL PEX PIPE
АЛ. ПЕХ ТРУБА**

CODE КОД	SIZE (Ø) РАЗМЕР	1 BOX QUANTITY ЕД. В 1 КОРОБКЕ	WEIGHT (kg) ВЕС ЗА ЕД.
60PEX07	Ø16mm-2.0mm	100 m	-
60PEX08	Ø20mm-2.0mm	100 m	-

**(20mm) EKSANTRİK KADA / OFFSET RIGID WC CONNECTOR
ДОПОЛНИТЕЛЬНЫЙ СИФОН**

CODE КОД	SIZE (Ø) РАЗМЕР	1 BOX QUANTITY ЕД. В 1 КОРОБКЕ	WEIGHT (kg) ВЕС ЗА ЕД.
60KAD06	Ø110mm	40	0,264

**PERT BORU / PERT PIPE
ПЕРТ ТРУБА**

CODE КОД	SIZE (Ø) РАЗМЕР	1 BOX QUANTITY ЕД. В 1 КОРОБКЕ	WEIGHT (kg) ВЕС ЗА ЕД.
60PERT09	Ø16mm-2.0mm	100 m	-
60PERT10	Ø20mm-2.0mm	100 m	-

**(40mm) EKSANTRİK KADA / OFFSET RIGID WC
CONNECTOR / ДОПОЛНИТЕЛЬНЫЙ СИФОН**

CODE КОД	SIZE (Ø) РАЗМЕР	1 BOX QUANTITY ЕД. В 1 КОРОБКЕ	WEIGHT (kg) ВЕС ЗА ЕД.
60KAD07	Ø110mm	30	0,274

**PERT OKSİJEN BARIYERLİ / PERT OXYGEN BARRIER
ПЕРТ КИСЛОРОДНЫЙ БАРЬЕР**

CODE КОД	SIZE (Ø) РАЗМЕР	1 BOX QUANTITY ЕД. В 1 КОРОБКЕ	WEIGHT (kg) ВЕС ЗА ЕД.
60PERT11	Ø16mm-2.0mm	100 m	-
60PERT12	Ø20mm-2.0mm	100 m	-

**(60mm) EKSANTRİK KADA / OFFSET RIGID WC
CONNECTOR / ДОПОЛНИТЕЛЬНЫЙ СИФОН**

CODE КОД	SIZE (Ø) РАЗМЕР	1 BOX QUANTITY ЕД. В 1 КОРОБКЕ	WEIGHT (kg) ВЕС ЗА ЕД.
60KAD08	Ø110mm	30	0,304

**PERT KILIFLI / PERT WITH COVER BLUE & RED
ПЕРТ С КРЫШКОЙ СИНИЙ И КРАСНЫЙ**

CODE КОД	SIZE (Ø) РАЗМЕР	1 BOX QUANTITY ЕД. В 1 КОРОБКЕ	WEIGHT (kg) ВЕС ЗА ЕД.
60PERT13	Ø16mm-2.0mm	100 m	-
60PERT14	Ø20mm-2.0mm	100 m	-

**RÖĞAR ÇERÇEVE + KARAK / ROGAR FRAME + COVER
РАМА + КРЫШКА ROGAR**

CODE КОД	SIZE (Ø) РАЗМЕР	1 BOX QUANTITY ЕД. В 1 КОРОБКЕ	WEIGHT (kg) ВЕС ЗА ЕД.
60RCK02	30x30mm	10	0,850
60RCK04	40x40mm	10	1,782
60RCK08	50x50mm	5	2,630
60RCK09	60x60mm	4	5,668

**ÇERÇEVLİ YUVARLAK DÜZ KARAK
FRAME ROUND FLAT COVER
РАМА КРУГЛАЯ ПЛОСКАЯ КРЫШКА**

CODE КОД	SIZE (Ø) РАЗМЕР	1 BOX QUANTITY ЕД. В 1 КОРОБКЕ	WEIGHT (kg) ВЕС ЗА ЕД.
60MBK36	Ø600 mm	1	2,607

**RÖĞAR KARAKLI KUTU / WINDOW LID BOX
ОКНА КРЫШКИ**

CODE КОД	SIZE (Ø) РАЗМЕР	1 BOX QUANTITY ЕД. В 1 КОРОБКЕ	WEIGHT (kg) ВЕС ЗА ЕД.
60RGA25	25x25 mm	1	1,134
60RGA35	35x35 mm	1	2,738

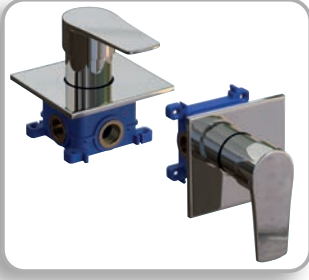

PRİNÇ 2 GİRİŞ 1 ÇIKIŞ ANKASTRE BANYO BATARYASI / BRASS 2 IN 1 OUT BATTERY CONNECTION

CODE KOĐ	SIZE (Ø) PA3MEP	KARTUŞ ÇAP CARTRIDGE DIAMETER	KANAL KALINLIK TUNNEL DIAMETER
4429420	1/2"	45 mm	13 mm

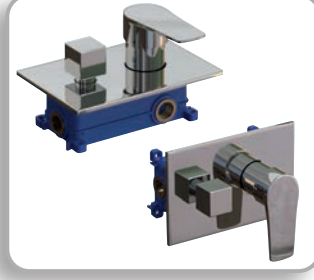

PRİNÇ 2 GİRİŞ 2 ÇIKIŞ ANKASTRE BANYO BATARYASI / BRASS 2 IN 2 OUT BATTERY CONNECTION

CODE KOĐ	SIZE (Ø) PA3MEP	KARTUŞ ÇAP CARTRIDGE DIAMETER	KANAL KALINLIK TUNNEL DIAMETER
4429520	1/2"	40 mm	13 mm



PRİNÇ 2 GİRİŞ 1 ÇIKIŞ ANKASTRE BANYO BATARYASI / BRASS 2 IN 1 OUT BATTERY CONNECTION

CODE KOĐ	SIZE (Ø) PA3MEP	KARTUŞ ÇAP CARTRIDGE DIAMETER	KANAL KALINLIK TUNNEL DIAMETER
4429620	1/2"	47 mm	13 mm

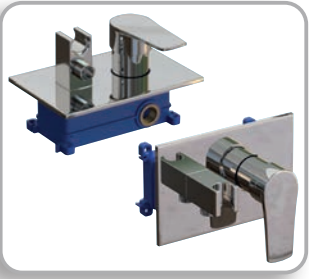

PRİNÇ 2 GİRİŞ 1 ÇIKIŞ ANKASTRE BANYO BATARYASI / BRASS 2 IN 1 OUT BATTERY CONNECTION

CODE KOĐ	SIZE (Ø) PA3MEP	KARTUŞ ÇAP CARTRIDGE DIAMETER	KANAL KALINLIK TUNNEL DIAMETER
4429720	1/2"	47 mm	13 mm

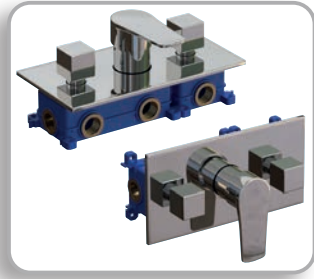

PRİNÇ 3 GİRİŞ 3 ÇIKIŞ ANKASTRE BANYO BATARYASI / BRASS 3 IN 3 OUT BATTERY CONNECTION

CODE KOĐ	SIZE (Ø) PA3MEP	KARTUŞ ÇAP CARTRIDGE DIAMETER	KANAL KALINLIK TUNNEL DIAMETER
4429820	1/2"	45 mm	13 mm

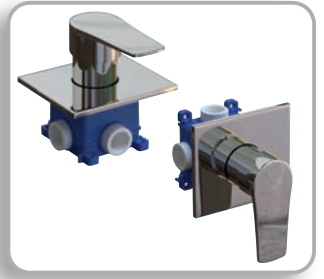

PPR-C 2 GİRİŞ 1 ÇIKIŞ ANKASTRE BANYO BATARYASI / PPR-C 2 IN 1 OUT BATTERY CONNECTION

CODE KOĐ	SIZE (Ø) PA3MEP	KARTUŞ ÇAP CARTRIDGE DIAMETER	KANAL KALINLIK TUNNEL DIAMETER
4429925	1/2"	45 mm	17 mm

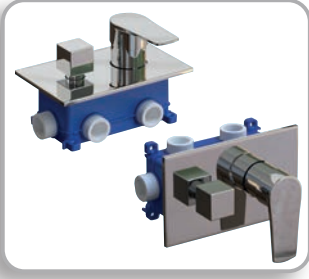

PPR-C 2 GİRİŞ 3 ÇIKIŞ ANKASTRE BANYO BATARYASI / PPR-C 2 IN 3 OUT BATTERY CONNECTION

CODE KOĐ	SIZE (Ø) PA3MEP	KARTUŞ ÇAP CARTRIDGE DIAMETER	KANAL KALINLIK TUNNEL DIAMETER
4430025	25mm	45 mm	17 mm

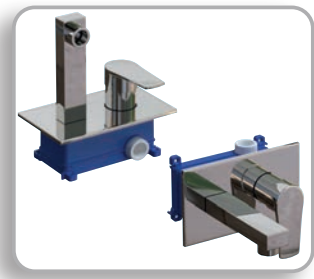

PPR-C 2 GİRİŞ 1 ÇIKIŞ ANKASTRE BANYO BATARYASI / PPR-C 2 IN 1 OUT BATTERY CONNECTION

CODE KOĐ	SIZE (Ø) PA3MEP	KARTUŞ ÇAP CARTRIDGE DIAMETER	KANAL KALINLIK TUNNEL DIAMETER
4430125	25mm	45 mm	17 mm

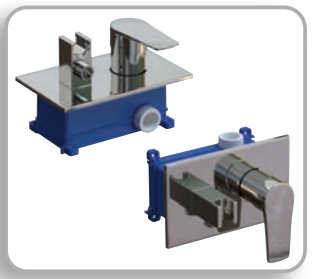

PPR-C 2 GİRİŞ 1 ÇIKIŞ ANKASTRE BANYO BATARYASI / PPR-C 2 IN 1 OUT BATTERY CONNECTION

CODE KOĐ	SIZE (Ø) PA3MEP	KARTUŞ ÇAP CARTRIDGE DIAMETER	KANAL KALINLIK TUNNEL DIAMETER
4430225	25mm	45 mm	17 mm

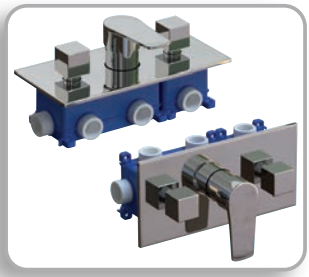

PPR-C 3 GİRİŞ 3 ÇIKIŞ ANKASTRE BANYO BATARYASI / PPR-C 3 IN 3 OUT BATTERY CONNECTION

CODE KOĐ	SIZE (Ø) PA3MEP	KARTUŞ ÇAP CARTRIDGE DIAMETER	KANAL KALINLIK TUNNEL DIAMETER
4430325	25mm	45 mm	17 mm

Ferhatpaşa Mah.
Mareşal Fevzi Çakmak Cad.
35 Sok. No: 48 Ataşehir
İstanbul / TURKEY
0090 216 230 0322
0090 216 230 0324
info@vala.com.tr
vala.com.tr



valabybabanyo



valabathroom



valabathroom



ebabanyo



valabathroom

VALA